

# DOMINATOR EasyRoller® 14

Rolling Door Opener

## Instruction Manual

(Instruction d'Installation)



Conforms to UL 325  
Certified to CSA  
C22.2 No.247

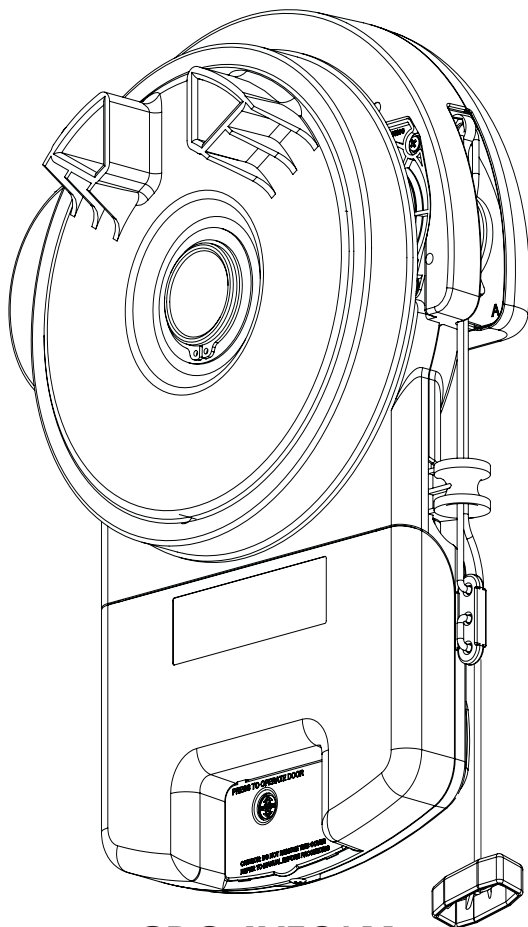

**GDO-6V5CAM**

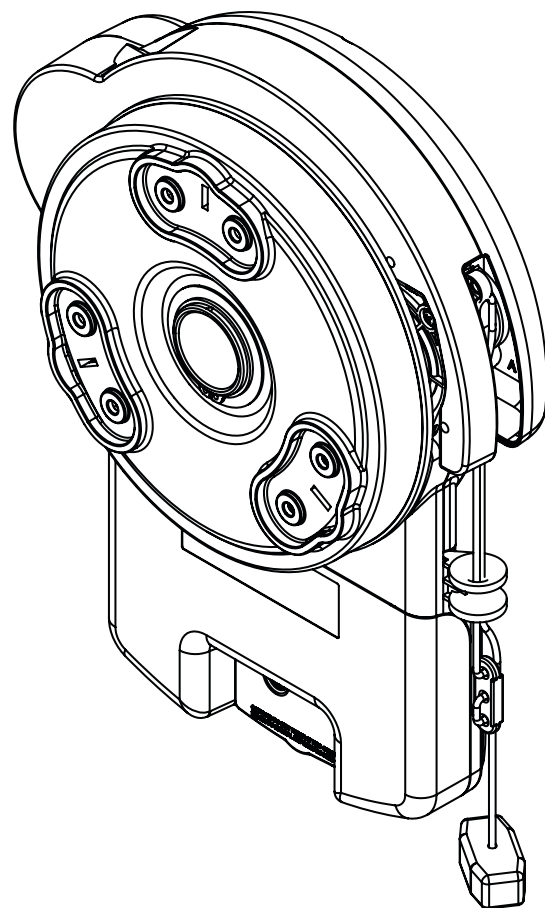

**GDO-6V5AM**

**FOR USE WITH EITHER RESIDENTIAL OR  
LIGHT-DUTY COMMERCIAL DOORS**

# CONTENTS

## Rolling Garage Door Operator

<b>1. System Specifications</b>	<b>3</b>	<b>6.8 Testing &amp; Setting Safety Obstruction Force</b>	<b>16</b>
<b>2. Safety Information</b>	<b>4</b>	6.8.1 Testing the Close Cycle	16
<b>3. Kit Contents</b>	<b>6</b>	6.8.2 Testing the Open Cycle	16
<b>4. Setup Requirements</b>	<b>6</b>	6.8.3 To Increase Force Pressure	17
4.1 Tools Required	6	6.8.4 To Decrease Force Pressure	17
4.2 The Opener:	7	6.8.5 To Recall Factory Set Force	17
4.3 Unsuitable Door Types	7	6.8.6 To Re-Profile the Door	17
4.4 Sideroom	7	<b>6.9 Accessories</b>	<b>18</b>
<b>5. Operator Safety &amp; Security</b>	<b>8</b>	6.9.1 Terminal Block	18
5.1 Your Door CAN NOT be used when:	8	6.9.2 Installation of Wall Mounted Transmitter	18
5.2 Your Door CAN be used when:	8	<b>6.10 Coding Transmitters</b>	<b>19</b>
5.3 To Disengage the Opener:	8	6.10.1 Setting Transmitters Codes	20
5.4 To Re-Engage the Opener:	8	6.10.2 Remotely Coding Transmitters	20
<b>6. Installation Instructions</b>	<b>9</b>	6.10.3 Coding for Vacation Mode	20
<b>6.1. Door Preparation</b>	<b>10</b>	6.10.4 Coding for AUX Output	20
<b>6.2. Fit the Weight Bar</b>	<b>10</b>	6.10.5 Coding for PET (Pedestrian) Mode	21
<b>6.3. Pinning the Door</b>	<b>11</b>	6.10.6 Coding for Courtesy Light	21
<b>6.4 Proping the Door</b>	<b>11</b>	6.10.7 Erasing a Stored Transmitter Code	21
<b>6.5. Mounting the Opener</b>	<b>12</b>	6.10.8 Erasing ALL Transmitter Codes	21
6.5.1 Raising the Door:	12	<b>6.11 Auto-Close</b>	<b>22</b>
6.5.2 Install the Prongs or Drum Adaptor:	12	6.11.1 Safety Beams	22
6.5.3 Mounting the Opener:	12	6.11.2 Auto Close Option	22
<b>6.6 Safety Beam Installation</b>	<b>13</b>	<b>6.12 Attach Warning Labels / Placards</b>	<b>22</b>
6.6.1 Safety Infra-Red Beam Kit (P/N 62047)	13	<b>7. Operation Instructions</b>	<b>23</b>
6.6.2 Assembling the Mounting Bracket	13	<b>7.1 How to Use Your Operator</b>	<b>24</b>
6.6.3 PE Assist Alignment	13	7.1.1 To Operate the opener:	24
<b>6.7. Setting the Travel Limits</b>	<b>14</b>	7.1.2 Replacing the Battery: 3V Lithium Battery CR2032.	24
6.7.1 Initial Preparation:	14	<b>7.2 User Operating Controls</b>	<b>25</b>
6.7.2 Set the Limit Positions:	14	<b>7.3. Door Status Indicators</b>	<b>25</b>
6.7.3 Clearing the Door Limit Positions	15	<b>8. Troubleshooting</b>	<b>26</b>
6.7.4 Controller Memory Reset	15	<b>9. User Maintenance Instruction</b>	<b>27</b>
6.7.5 Re-profiling the Door	15	9.1 Door Maintenance	27
6.7.6 Setting the PET Mode position	15	9.2 If You Need a Service Call	27



# 1. System Specifications

Technical Specifications	Dominator EasyRoller® 14 GDO-6V5AM	Dominator EasyRoller® 14 GDO-6V5CAM
Power supply	120Va.c. 60Hz	120Va.c. 60Hz
Type of door: Maximum Door Weight: Maximum Door Area:  Door must be well balanced and able to be operated by hand, as per warranty conditions and standard UL 325	Rolling Sheet Door 242lb 178ft <sup>2</sup>	Rolling Sheet Door 242lb 178ft <sup>2</sup>
Internal gear	2 x rounded prongs OR 1 x large single prong	fixed prongs with drum adaptor kit
Minimum sideroom	1 9/16"	1 9/16"
Nominal force	200N (44lb)	200N (44lb)
Receiver type	Multi-frequency UHF FM	Multi-frequency UHF FM
Receiver code storage capacity	64 X 4-button Transmitters	64 X 4-button Transmitters
Coding System	TrioCode™ 128 Type	TrioCode™ 128 Type
Coding type	Non-linear encryption algorithm	Non-linear encryption algorithm
Number of code combinations	Over 100 billion random codes	Over 100 billion random codes
Transmitter battery	CR2032 (3 Volts)	CR2032 (3 Volts)
Courtesy light	LED (Light Emitting Diodes)	LED (Light Emitting Diodes)
Network connectivity	Network compatible, (requires optional Smart Phone Control Kit)	Network compatible, (requires optional Smart Phone Control Kit)
Type of entrapment protection	Photo Electric Beam	Photo Electric Beam

Note: Intermittent operations may occur in areas which experience very strong winds. The strong wind puts extra pressure on the door and tracks which may in turn intermittently trigger the safety obstruction detection system.

# 2. Safety Information



**WARNING!** It is vital for the safety of persons to follow all instructions. Failure to comply with the installation instructions and the safety warnings may result in serious personal injury and/or property and remote control opener damage. Please save these instructions for future reference.

- This operator should be installed in accordance with relevant US and Canada Standards.
- To reduce the risk of injury to persons – Use this operator only with a rolling door. The drive must not be used with a door incorporating a wicket door, unless the drive cannot be operated with the wicket door open.
- This operator is a plug in domestic appliance and is designed for indoor use only. It must be installed in a dry position that is protected from the weather.
- Door must have Safety Beams fitted.
- Activate the operator only when the garage door is in full view, free of obstructions and with the operator properly adjusted.
- The network device allows for operation of the door when not in line-of-sight of the door and operator. Therefore the door may operate unexpectedly, therefore do not allow anything to stay in or near the path of the door.
- Watch the moving door and keep people away until the door is completely opened or closed.



**ELECTROCUTION:** To reduce the risk of electric shock, this equipment has a grounding type plug that has a third (grounding) pin. This plug will only fit into a grounding type outlet. If the plug does not fit into the outlet, contact a qualified electrician to install the proper outlet. Do not change the plug in any way. This operator is not equipped for permanent wiring. Contact a qualified electrician to install a suitable receptacle if one is not available.

- Installation and wiring must be in compliance with your local building and electrical codes.
- If the power cord is damaged, it must be replaced by the manufacturer, its service agent or a similarly qualified person in order to avoid a hazard.
- Connect the power cord only to properly earthed mains. If an extension lead must be used, make sure it is a 3-core lead and approved to 7 amp capacity.
- This unit is not user serviceable. Unplug the power cord before removing the cover. Ensure that the power cord is attached clear of all moving parts. Ignoring these instructions can cause electric shock.

Please read these important safety rules

These safety alert symbols indicate a personal safety or property damage instruction exists. **READ THESE INSTRUCTIONS CAREFULLY.**

**This automatic garage door operator is designed and tested to offer safe service provided it is installed and operated in strict accordance with the following safety rules. Failure to comply with the installation instructions and the safety warnings may result in death, serious personal injury and/or property damage.**



**CAUTION:**

- If your garage has no pedestrian entrance door, an emergency access device should be installed. This accessory allows manual operation of the garage door from outside in case of power failure.
- Keep the garage door balanced. Sticking or binding doors must be repaired. Garage doors, door springs, brackets and their hardware are under extreme tension and can cause serious personal injury. Do not attempt any garage door adjustment. Do not use if repair or adjustment is needed. Call for professional garage door service.
- Position the Garage Door Operator so that the power plug is accessible when inserted into the power outlet.
- Install the wall transmitter in a location where the garage door is visible, but out of the reach of children at a height of at least 5 feet (1.53m).
- To avoid serious personal injury from entanglement, remove all unnecessary ropes or chains and disable any equipment such as locks which are not needed for powered operation.
- Do not wear rings, watches or loose clothing while installing or servicing a garage door operator.
- Ensure ladder is the correct type for the job and is on flat ground. We recommend the user has 3 points of contact while on ladder.
- Activate the operator only when the garage door is in full view, free of obstructions and with the operator properly adjusted.
- The operator is not intended for use by young children or infirm persons without supervision.
- Keep transmitters away from children.
- Do not allow children to play with door controls.

## 2. Sécurité



**AVERTISSEMENT !** pour la sécurité des usagers, il est essentiel de suivre toutes les instructions. Le non-respect des instructions d'installation et des avertissements de sécurité peut causer de graves blessures et/ou endommager l'appareil et la télécommande. Conservez ces instructions en lieu sûr.

- Cet appareil doit être installé conformément aux normes US et canadiennes en vigueur.
- Pour réduire les risques d'accident, n'utiliser cet appareil qu'avec une porte de garage enroulable. Ce moteur ne doit pas être utilisé avec une porte de garage avec portillon, à moins que le moteur ne puisse fonctionner quand le portillon est ouvert.
- Cet appareil est un accessoire domestique conçu pour être utilisé uniquement à l'intérieur. Il doit être installé au sec et à l'abri des intempéries.
- La porte doit être équipée de faisceaux de sécurité.
- Activez l'appareil uniquement lorsque la porte du garage est à la vue, exempte d'obstacles et avec l'appareil bien réglé.
- La télécommande radio permet d'actionner la porte lorsque l'utilisateur est hors de la ligne de vue de la porte et de l'appareil. En conséquence, la porte risque de s'ouvrir ou se fermer inopinément et vous devez éviter de laisser des objets sur sa course ou à proximité.
- Suivez la porte pendant l'ouverture ou la fermeture, et veillez à ce que personne ne se trouve à proximité tant qu'elle n'est pas complètement ouverte ou fermée.



**ÉLECTROCUTION :** Pour réduire les risques d'électrocution, cet appareil est équipé d'une fiche avec broche de mise à la terre. Cette fiche ne peut être branchée que dans une prise avec mise à la terre. S'il n'est pas possible de la brancher dans la prise, faites poser une prise appropriée par un électricien qualifié. Ne pas modifier la fiche. Ce matériel est pas équipé pour le câblage permanent. En l'absence de réceptacle approprié, contactez un électricien qualifié pour en installer un.

- L'installation et le câblage doivent être effectués conformément aux codes de la construction et de l'électricité en vigueur.
- Si le cordon électrique est abîmé, il doit être remplacé par le fabricant, son SAV agréé ou un technicien qualifié.
- Branchez le cordon électrique uniquement à une prise secteur dûment reliée à la terre. Si vous devez utiliser une rallonge, assurez-vous qu'elle est tripolaire et d'une capacité de 7 ampères.
- Cet appareil n'est pas réparable par l'utilisateur. Avant de retirer le capot, débranchez le cordon électrique. Assurez-vous qu'il ne risque pas d'entrer en contact avec des pièces en mouvement. Le non-respect de ces instructions peut avoir une électrocution pour conséquence.

Lisez attentivement ces règles de sécurité.

Ces pictogrammes indiquent une consigne de sécurité pour les personnes ou les biens. **LISEZ CES INSTRUCTIONS ATTENTIVEMENT.**

**Cette commande automatique pour porte de garage est conçue et testée pour fonctionner en toute sécurité. Pour ce faire, elle doit être installée et utilisée dans le strict respect des règles de sécurité suivantes. Le non-respect des instructions d'installation et des avertissements présente un risque de mort, de blessure grave et/ou de préjudice pour les biens.**



### PRUDENCE :

- Si votre garage ne comporte pas de porte pour piétons, il convient d'installer un dispositif d'accès d'urgence. Cet accessoire permet d'actionner la porte de garage manuellement de l'extérieur en cas de panne d'électricité.
- Veillez à ce que la porte du garage soit bien équilibrée. Si une porte reste « collée » ou qu'elle « accroche », elle doit être réparée. Les portes de garage, les ressorts de porte, les pattes de fixation et les éléments matériels sont soumis à une tension extrême et peuvent blesser gravement. Ne tentez pas de régler la porte de garage par vous-même. Ne l'utilisez pas si une réparation ou un réglage est nécessaire. Faites appel à un technicien spécialisé.
- Positionnez le dispositif de commande de manière à ce que la prise de courant soit accessible lorsqu'elle est branchée.
- Installez l'émetteur mural à un emplacement où la porte du garage est visible, mais hors de portée des enfants, à une hauteur d'au moins 1,50 m.
- Rangez cordes et chaînes pour éviter de vous blesser, et désactivez les serrures et autres équipements qui ne sont pas nécessaires pour une utilisation sous tension.
- Pendant l'installation ou la réparation d'un dispositif de commande de porte de garage, retirez bijoux et montre, et attachez vos vêtements.
- Utilisez un escabeau adéquat et stable. Lorsque l'utilisateur se tient sur un escabeau, il est conseillé de veiller à ce que les points de contact soient au nombre de trois.
- Activez l'appareil uniquement lorsque la porte du garage est à la vue, exempte d'obstacles et avec l'appareil bien réglé.
- L'appareil ne doit pas être utilisé sans supervision par de jeunes enfants ou des personnes infirmes.
- Les émetteurs doivent rester hors de portée des enfants.
- N'autorisez pas les enfants à jouer avec les commandes de porte.

# 3. Kit Contents

1. Dominator EasyRoller
  - a. 1 x GDO-6V5AM Drive unit with Adaptor kit OR
  - b. 1 x GDO-6V5CAM Drive unit with Prong kit
    - (i) 2 x Rounded Prongs kit OR
    - (ii) 1 x Large Single Prong kit
2. 2 x PTX-6V1AM Transmitters
3. 1 x Wall Mount Transmitter
4. 2 x Locking Bar Covers
5. 1 x Wired Safety Beam kit with brackets and screws
6. 1 x Weight Bar
7. 2 x Nilock Nut
8. 2 x  $\frac{3}{16}$ " x  $\frac{1}{2}$ " flat washers
9. 2 x Pan Head Screw 8-36 x 2"

Fig. 3.1

# 4. Setup Requirements

## 4.1 Tools Required

Stepladder

Towel

Rope

Door Stand or suitable prop

Drill

Self-tapping Screws and Washers (M10 x 32mm)

Screwdrivers

Sockets and Wrench

Pencil

Adjustable End Wrench

# 4. Setup Requirements

## 4.2 The Opener:

- MUST BE installed in a dry position, protected from weather. (Moisture or corrosion not covered by Warranty)
- Is factory set for RIGHT HAND SIDE installation (from inside garage), but capable of LEFT HAND SIDE installation. Fig 4.2.1
- REQUIRES properly earthed 3 pin single phase power within an arms length of door and at a suitable height
- Requires a MINIMUM SIDEROOM of  $1 \frac{9}{16}$ " from the edge of the door to the inside of the door bracket and  $3 \frac{3}{8}$ " to the wall.
- CAN NOT be installed on a Door Axle Diameter that exceeds  $1 \frac{3}{8}$ ".

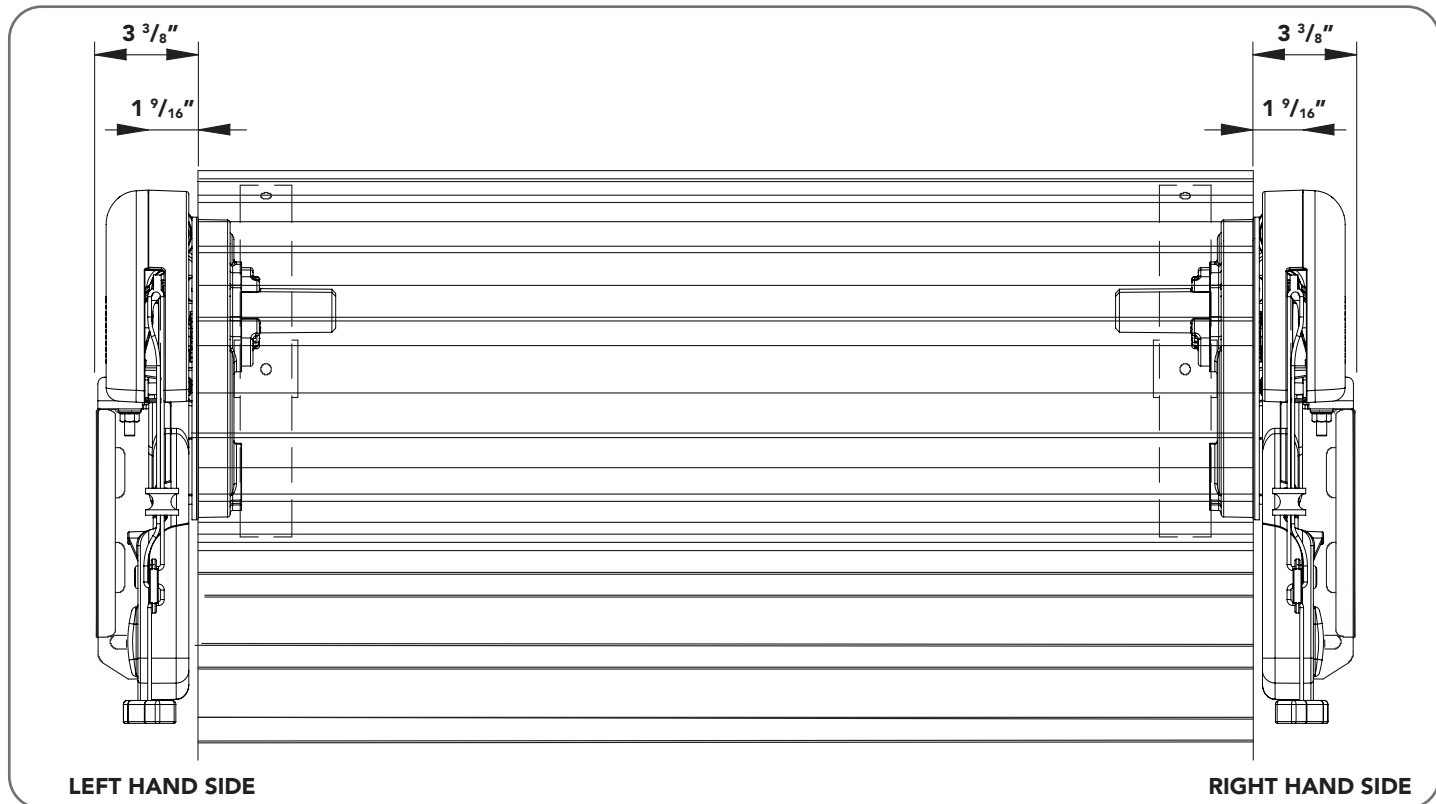

Fig. 4.2.1



**WARNING!** This operator is not equipped for permanent wiring. Contact a qualified electrician to install a suitable receptacle if one is not available.

**AVERTISSEMENT!** Ce dispositif d'ouverture n'est pas conçu pour un câblage permanent. En l'absence de réceptacle approprié, contactez un électricien qualifié pour en installer un.



**CAUTION:** Do not connect opener to power source until instructed to do so.

**ATTENTION:** Ne branchez pas l'ouvre-porte avant d'être autorisé par la notice.

## 4.3 Unsuitable Door Types

The drive must not be used with a door incorporating a wicket door, unless the drive cannot be operated with the wicket door open. The fitting of an opener to doors with removable mullions is not recommended.

## 4.4 Sideroom

The minimum sideroom required from the edge of the door curtain is  $1 \frac{9}{16}$ " to the inside of the door bracket, and  $3 \frac{3}{8}$ " to the wall. If a Battery Backup is to be fitted, at least  $5 \frac{5}{16}$ " to the bracket is required.

Therefore the recommended sideroom from the edge of the door curtain is  $5 \frac{5}{16}$ " to the inside of the door bracket, and  $6 \frac{7}{8}$ " to the wall as per Fig 4.4.1.

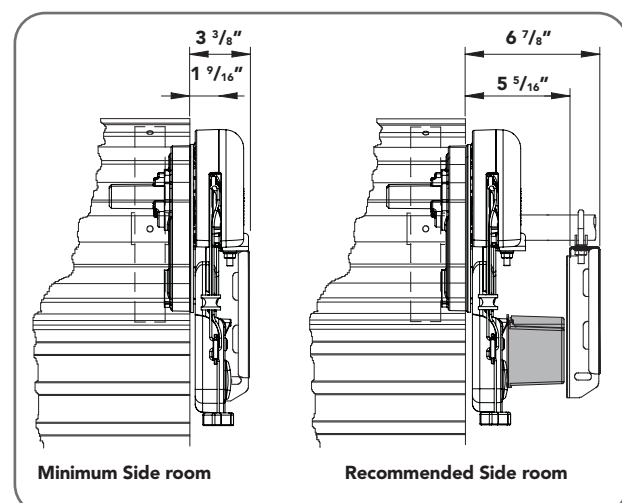

Fig. 4.4.1

# 5. Operator Safety & Security

## 5.1 Your Door CAN NOT be used by the opener when:

- There is a locking device installed.
- There is a power failure.

## 5.2 Your Door CAN be used when:

- There is an emergency, by disengaging the opener.
- There is a power failure, by disengaging the opener.

## 5.3 To Disengage the Opener:

**tip** It is recommended to disengagere the door with the door in the closed position.

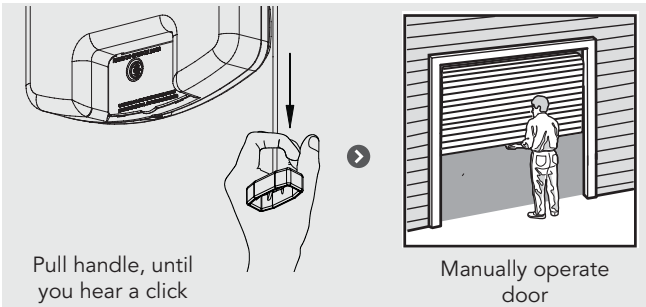

**CAUTION:** When the opener is manually disengaged, the door is no longer locked. To lock the door manually, re-engage the opener after the door is closed.

**ATTENTION:** Ne pas utiliser la poignée de chaîne pour ouvrir la porte. Le non-respect de cette consigne peut provoquer des blessures graves.

## 5.4 To Re-Engage the Opener:

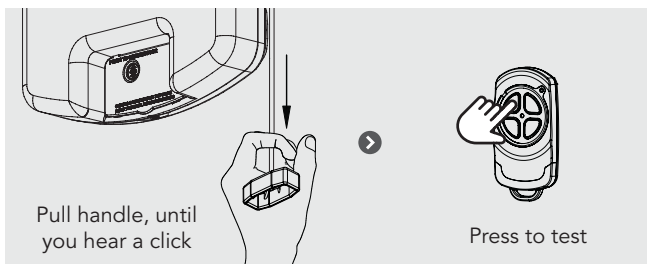

**WARNING!** Please test the manual release mechanism to ensure that the manual release is easy to operate. No more than 44lbs (20kg) of force should be required to disengage the door using the manual release cord. IF excessive force is required, reset the close limit position.

**AVERTISSEMENT!** Tester le dispositif de déclenchement manuel afin de s'assurer que le système se désengage facilement. Ne pas exercer une force de plus de 44lb (20kg) pour désengager la porte en tirant sur le cordon. Si la force à appliquer est excessive, il faudra re-paramétrer le réglage de fin de course.

**MANUAL RELEASE**

○

**WARNING!** When operating the manual release (while the door is open) the door may fall rapidly due to weak or broken springs, or due to being improperly balanced.  
Do not disengage the operator to manual operation with children/persons or any objects including motor vehicles within the doorway.

**IN THE EVENT THE DOOR BECOMES OBSTRUCTED DETACH DOOR FROM OPERATOR AS FOLLOWS:**

**1. TO DISENGAGE:**  
PULL HANDLE DOWN & RELEASE

**SI LA PORTE EST BLOQUÉE, DÉTACHEZ-LA DU DISPOSITIF DE COMMANDE EN PROCÉDANT COMME SUIT :**

**1. POUR DÉBLOQUER:**  
TIRER VERS LE BAS ET RELACHER

**2. TO RE-ENGAGE: REPEAT ACTION**

**2. POUR LA RÉENGAGER:**  
RÉPÉTER LE MOUVEMENT

PULL HANDLE  
 TIRER LA POIGNEE

**AVERTISSEMENT :** Lorsque vous utilisez le déclenchement manuel (alors que la porte est ouverte), la porte peut tomber rapidement si les ressorts sont fatigués ou brisés, ou parce qu'elle est mal équilibrée.  
**NE PAS** désengager l'opérateur en mode manuel lorsque des enfants/personnes, ou des objets tels que des véhicules à moteur, sont dans le passage.

○

**DÉBLOCAGE MANUEL**

Fig. 5.1



## 6. Installation Instructions

### IMPORTANT INSTALLATION INSTRUCTIONS.

#### WARNING - To reduce the risk of severe injury or death:

- (1) READ AND FOLLOW ALL INSTALLATION INSTRUCTIONS.
- (2) Install only on a properly operating and balanced sheet door. An improperly balanced door has the potential to inflict severe injury. Have a qualified service person make repairs to cables, spring assemblies, and other hardware before installing the opener.
- (3) Remove all pull ropes and remove or make inoperative, all locks connected to the sheet door before installing opener.
- (4) Where possible, install the door opener 2.14m (7 feet) or more above the floor. For products having an emergency release, mount the emergency release 1.83m (6 feet) above the floor and avoiding contact with vehicles to avoid accidental release.
- (5) Do NOT connect the opener door operator to source of power until instructed to do so.
- (6) Locate the control button:
  - (i) within sight of door,
  - (ii) at a minimum height of 1.53m (5 feet) above floors, landings, steps or any other adjacent walking surface so small children are not able to reach it, and
  - (iii) away from all moving parts of the door.
- (7) Install the Entrapment Warning Label next to the control button in a prominent location.
- (8) After installing the opener, the door must reverse within 2 seconds when it contacts a 1 1/2-inch high object (or a 2 by 4 board laid flat) on the floor.
- (9) For products having a manual release, instruct the end user on the operation of the manual release.
- (10) The following wiring instructions:
  - (i) "This operator is not equipped for permanent wiring. Contact licensed electrician to install a suitable receptacle if one is not available." and;
  - (ii) "TO REDUCE THE RISK OF ELECTRIC SHOCK, THIS EQUIPMENT HAS A GROUNDING TYPE PLUG THAT HAS A THIRD (GROUNDING) PIN. THIS PLUG WILL ONLY FIT INTO A GROUNDING TYPE OUTLET. IF THE PLUG DOES NOT FIT INTO THE OUTLET, CONTACT A QUALIFIED ELECTRICIAN TO INSTALL THE PROPER OUTLET. DO NOT CHANGE THE PLUG IN ANY WAY."

### IMPORTANT - NOTICE D'INSTALLATION.

#### AVERTISSEMENT - POUR RÉDUIRE LES RISQUES DE BLESSURES GRAVES OU DE MORT :

- (1) LISEZ CETTE NOTICE ET CONFORMEZ-VOUS AUX INSTRUCTIONS.
- (2) NE POSEZ CET OUVERTE-PORTE QUE SUR UNE PORTE DE GARAGE CORRECTEMENT ÉQUILIBRÉE. UNE PORTE MAL ÉQUILIBRÉE PEUT CAUSER DES BLESSURES GRAVES. CONFIEZ LA RÉPARATION DES CÂBLES, DES RESSORTS ET DE TOUT AUTRE ÉLÉMENT À UN TECHNICIEN QUALIFIÉ AVANT D'ENTREPRENDRE L'INSTALLATION.
- (3) ENLEVEZ LES CORDES ET ENLEVEZ OU NEUTRALISEZ TOUT DISPOSITIF DE VERROUILLAGE SOLIDAIRE DE LA PORTE DE GARAGE AVANT L'INSTALLATION.
- (4) DANS LA MESURE DU POSSIBLE, INSTALLEZ L'OUVERTE-PORTE À AU MOINS 2.14M (7 PI) DU SOL. POSEZ LE DISPOSITIF DE DÉSACCOUPLEMENT D'URGENCE À AU MOINS 1.83M (6 PI) DU SOL EN ÉVITANT LE CONTACT AVEC DES VÉHICULES POUR ÉVITER TOUT DÉCLENCHEMENT ACCIDENTEL.
- (5) NE BRANCHEZ PAS L'OUVERTE-PORTE AVANT D'Y ÊTRE AUTORISÉ PAR LA NOTICE.
- (6) INSTALLEZ LE BOUTON DE COMMANDE:
  - (I) À UN ENDROIT QUE L'ON PEUT VOIR DE L'EMBRASURE DE LA PORTE ;
  - (II) À UNE HAUTEUR MINIMALE DE 1.53M (5 PI) DU SOL - AFIN QUE LES JEUNES ENFANTS NE PUISSENT PAS L'ATTEINDRE,
  - (III) À L'ÉCART DES PIÈCES MOBILES DE LA PORTE.
- (7) APOSEZ L'ÉTIQUETTE DE MISE EN GARDE RELATIVE AU DANGER DE HAPPEMENT À PROXIMITÉ DE BOUTON DE COMMANDE ET L'ÉTIQUETTE RELATIVE AU RÉGLAGE DE LA COMMANDE À UN EMPLACEMENT EN ÉVIDENCE - PAR EXEMPLE SUR LA PAROI INTÉRIEURE DE LA PORTE DE GARAGE OU SELON LES INSTRUCTIONS DE LA NOTICE D'INSTALLATION.
- (8) UNE FOIS L'OUVERTE-PORTE INSTALLÉ, LE SENS DE LA COURSE DOIT S'INVERSER LORSQUE LA PORTE ENTRE EN CONTACT AVEC UN OBJET D'UNE HAUTEUR DE 38 MM (1 1/2 PO) (OU UN MADRIER DE 2 X 4 PO DE SECTION, À PLAT) POSÉ SUR LE SOL.
- (9) Pour les produits munis d'un dispositif de desaccouplement manuel, indiquez à l'utilisateur final la procédure d'utilisation du dispositif.
- (10) Les instructions de câblage suivantes:
  - (i) "Cet operateur est pas equipe pour le cablage permanent. Contactez un electricien qualifie pour installer un receipt approprié si l'on est pas disponible."
  - (II) POUR RÉDUIRE LES RISQUES D'ÉLECTROCUTION, CET APPAREIL EST ÉQUIPÉ D'UNE FICHE AVEC BROCHE DE MISE À LA TERRE. CETTE FICHE NE PEUT ÊTRE BRANCHÉE QUE DANS UNE PRISE AVEC MISE À LA TERRE. S'IL N'EST PAS POSSIBLE DE LA BRANCHER DANS LA PRISE, FAITES POSER UNE PRISE APPROPRIÉE PAR UN ÉLECTRICIEN QUALIFIÉ. NE PAS MODIFIER LA FICHE

# 6.1. Door Preparation

## 6.1.1 Prepare the Door:

- Clean the guides if there is any oil or wax present using a suitable white spirit. The only lubricant suitable for use on door guides is silicon spray. DO NOT use WD-40, RP-7, petroleum grease, or similar.
- Remove the locking bars or disable the lock.
- Install the locking bar covers (4) if there are locking bar holes in the guides. This ensures fingers cannot be placed in the holes while the door operates. (Fig 6.1)
- Affix the supplied warning labels where they are clearly visible on the inside of the door.

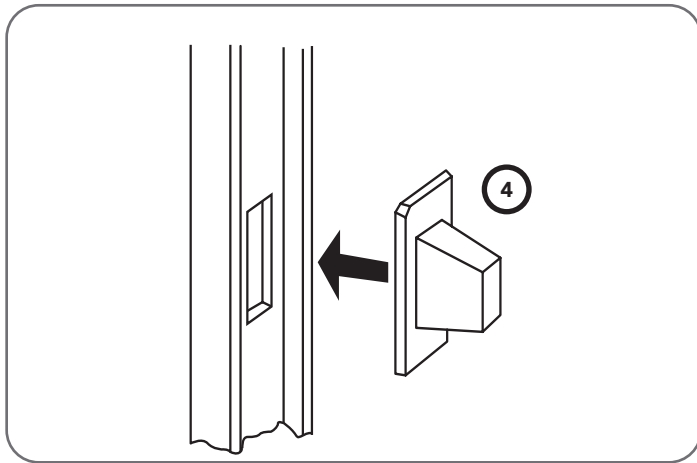

Fig. 6.1.1

# 6.2. Fit the Weight Bar

## 6.2.1 If the door has a handle a weight bar must be fitted to ensure the door doesn't balloon during operation:

- Remove the door handle
- Fit the weight bar (6) and refit the handle using the two (2) 8-36 x 2" Pan Head Screws (9) and the two (2) Flat Washer (8) and the two (2) M4 Nilock Hex nut (7). (Fig 6.2)

## 6.2.2 If the door does not have a handle:

- Locate the centre of the door at the bottom rail.
- Place the weight bar at this point and mark the two positions where the fasteners will go
- Drill the two 4.5mm holes in the door and fit the weight bar (6) using the two (2) 8-36 x 2" Pan Head Screws (9) and the two (2) Flat Washer (8) and the two (2) M4 Nilock Hex nut (7).
- Check that the door is still balanced and smooth. If not, then the door may require servicing.

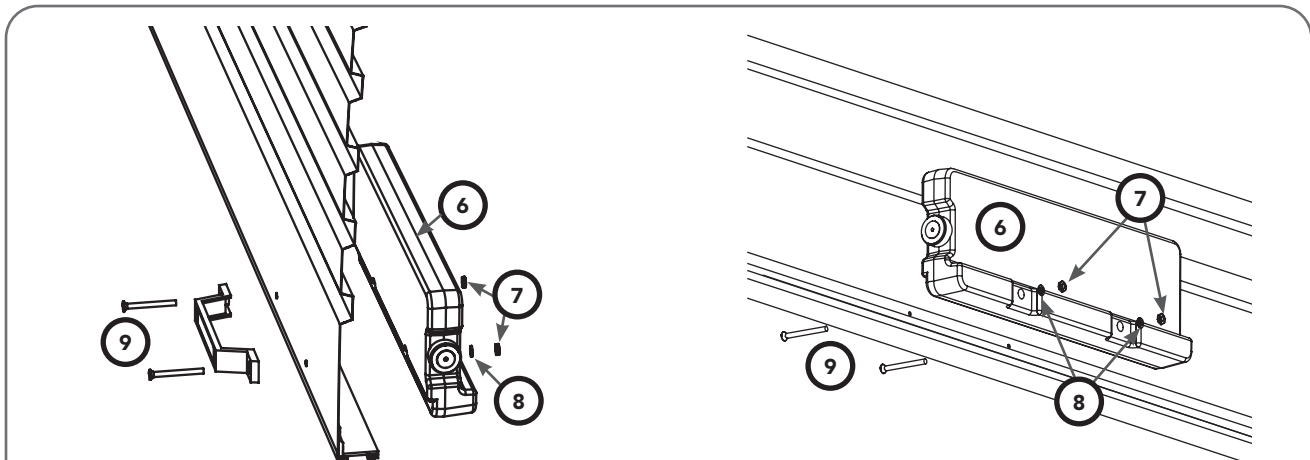

Fig. 6.2.1

## 6.3. Pinning the Door

### 6.3.1 Pinning the Door to the drum:

**NOTE: Pinning of the door is mandatory and is primarily required in order for the inherent entrapment protection to function properly.** Pinning the door's curtain to its drum maintains security when the opener is closed. If the curtain is not pinned the door can be partially opened manually. (Fig 6.3.1)

- Fully close the door.
- Mark a minimum of two (2) drill holes on the drum to each end of the door. (Fig 6.3.2)
- Drill holes using 3.2mm ( $1/8$ " ) drill bit.
- Fit M10 x 32mm screws and washers (not supplied) to each of the four (4) holes. This screw should be positioned as low as possible in the groove, but make sure that it does not alter the curtain's normal lead in to the guide.

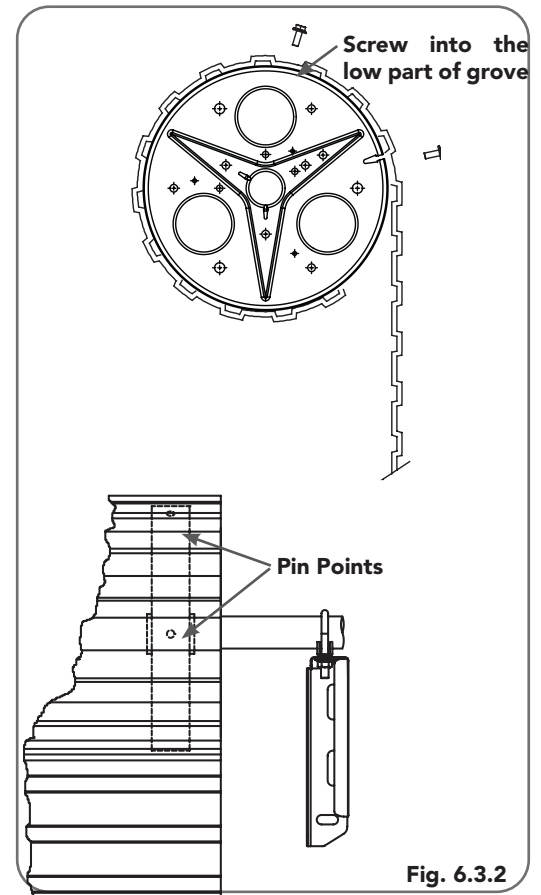
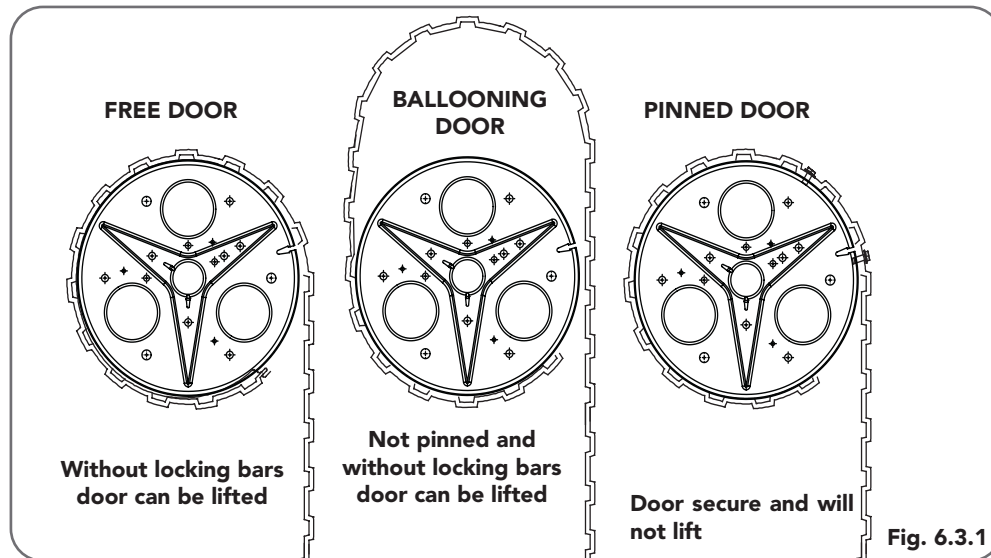

## 6.4 Propping the Door

**WARNING!** Do not allow children/persons around the door and prop. Serious personal injury and/or property damage can result from failure to follow this warning.  
**AVERTISSEMENT!** Il est interdit de passer sous la porte ou de passer à proximité du support placé sous la porte. Le non-respect de cette consigne peut entrainer des blessures graves ou des dommages matériels.

### 6.4.1 Prepare the Door:

- At the end opposite to where the opener will be fitted, check that the U-bolt which holds the door axle to the bracket is tightened securely.

**WARNING!** The U-bolt must be done up tightly to ensure the stored energy in the springs cannot be unexpectedly released.

**AVERTISSEMENT!** Bien serrer la fixation en U de manière à contenir l'énergie du ressort sous tension.

- Open the door completely and tie rope around the door roll. Do not tie the rope too tight as damage to the curtain may ensue. This will stop the door unrolling when taken off the bracket
- At the end where the opener is to be fitted, support the door with a door stand or suitable prop. Place a towel between the door and the prop to protect the door from damage.

**WARNING!** Make sure the prop is snug under the door and is stable.

**AVERTISSEMENT!** Vérifier que le support est positionné correctement sous la porte et ne risque pas de tomber.

- At the end where the opener will be fitted use a pencil to mark the position of the U-bolt in the door bracket and the position of the door bracket on the wall to assist in reassembling.

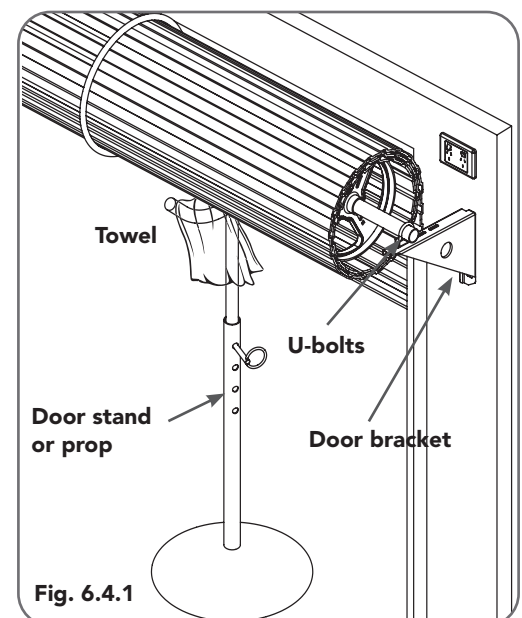

# 6.5. Mounting the Opener

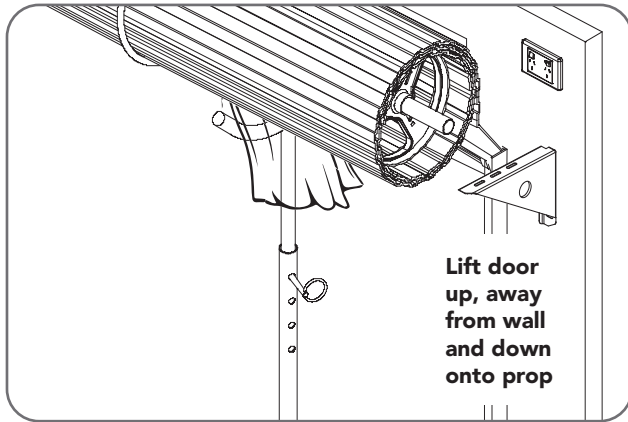

Fig. 6.5.1

Lift door up, away from wall and down onto prop

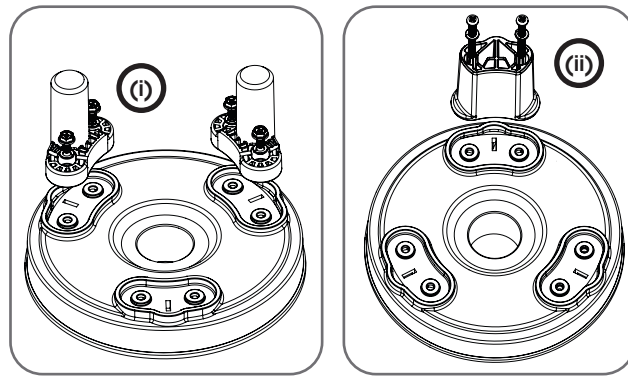

Fig. 6.5.2a

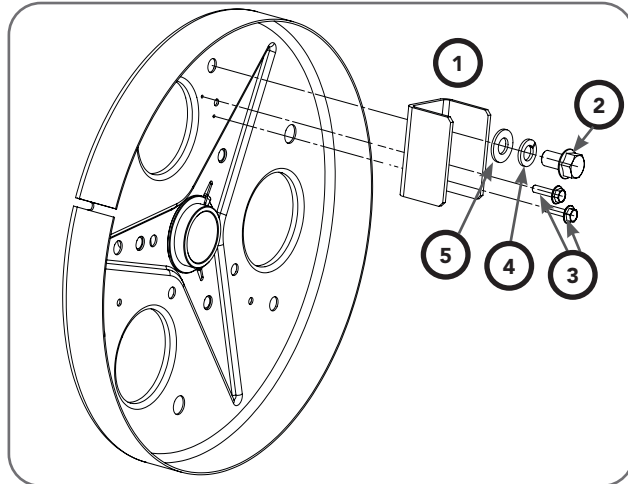

Fig. 6.5.2b

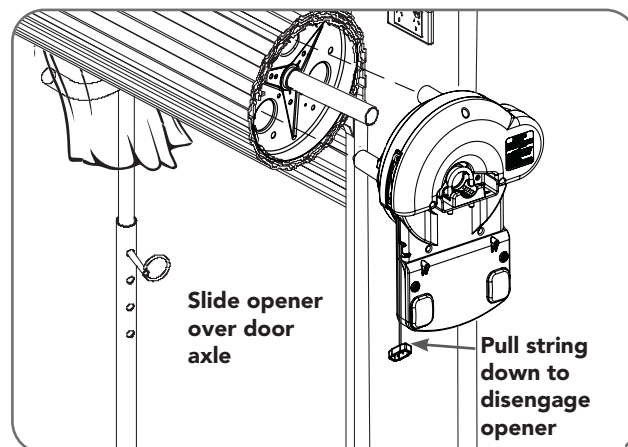

Fig. 6.5.3

Slide opener over door axle

Pull string down to disengage opener

## 6.5.1 Raising the Door:

- When in position, remove the U-bolt (or bolts) and saddle from the door bracket.
- Lift the door up and away from the wall until clear of the door bracket, before lowering the door to rest on the door stand or prop. (Fig 6.5.1)

**NOTE:** If there is limited ceiling space to lift the door, the door bracket may have to be removed. If this is required, when refitting the door bracket, use the reference marks on the wall for correct position and ensure that it is secure to the wall and will support the door.

**NOTE:** For tight sideroom installations the door may have to be taken down.

## 6.5.2 Install the Prongs OR the Drum Adaptor

### Install the Prongs:

- Remove the prong kit (i) or (ii) from the box.
- Connect the prongs to the internal gear as shown in Fig 6.5.2 and secure it using fasteners supplied.

OR

### Install the Drum Adaptor:

- Remove the U Shape Adaptor from the box.
- Place the U Shape Adaptor (1) on the drum wheel as shown in Fig 6.5.2 and secure it using the spring (5) and flat washers (4), 2 x self tapping screws (3) and the hex head screw (2).

## 6.5.3 Mounting the Opener:

- Remove the opener from the box.
- Check the drive gear rotates freely, by pulling the string handle down (there will be a click) to disengage opener. Then move the forks from side to side by hand.
- Slide the opener over the door axle and into the drum of the door as shown in Fig 6.5.3.
- Push the opener in as far as possible (without interfering with the curtain) SO ONE OF THE DOOR DRUM'S WHEEL SPOKES IS BETWEEN THE OPENER'S DRIVE FORKS.
- Raise the door off the door stand or suitable prop.
- Lift up and over the door bracket and use your reference marks on the door bracket to position the door.

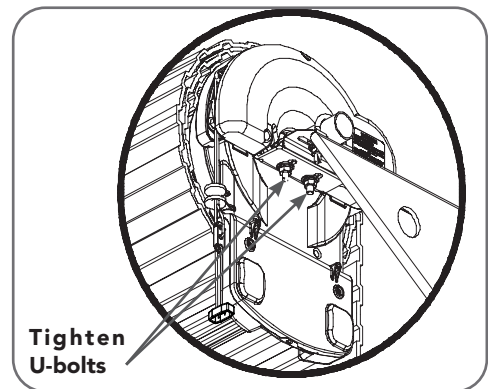

Fig. 6.5.4

- Refit the U-bolt and nuts and tighten (Fig 6.5.4).
- Remove the safety rope and door stand or prop.
- Connect the power cord to a suitable powerpoint, but **DO NOT SWITCH ON.**
- Secure the power cord away from any moving object (e.g the door) with the cable clip supplied.
- With the opener still disengaged, pull the door up and down to make sure it runs freely.

**NOTE:** After Installation, ensure that parts do not extend over public footpaths or roads.

# 6.6 Safety Beam Installation



**CAUTION:** The Safety Beam must be installed and connected before the travel limits are set.

**ATTENTION:** Le faisceau de sécurité doit être installé et connecté avant de définir les fins de course.

## 6.6.1 Safety Infra-Red Beam Kit (P/N 62047)

A Safety Beam extends across the door opening. This Safety Beam is designed to detect an obstruction while the door is closing and to send a signal to the door operator to reverse or stop the door movement. **Install the Safety Beam indoor only.**

## 6.6.2 Assembling the Mounting Bracket

- Place the round screw (3) through the Bracket (5). Attach the Safety Beam Transmitter (TX) using four (4) M3 x 5 Taptite screws (4) (Fig. 6.6.1).
- Connect the mounting bracket (2) to the Bracket (5) using the wing nut (8) onto the round screw (3). Secure the adjustment bracket (6) to the mounting bracket (2) using two (2) screws (3) and nuts (7).
- Repeat steps (a) and (b) to assemble the Safety Beam Receiver (RX).
- Locate the Safety Beam in a strategic location in the door opening. **We recommend** that the sensor is placed no higher than 6" and no lower than 5" above the floor level. The mounting surface should be rigid.

## 6.6.3 PE Assist Alignment

- Wire the PE Beams as per Wiring Diagram (Fig. 6.6.2).
- Power up the operator with the Safety Beam connected. The green LED of the transmitter should be ON to indicate that power is present.
- If the receiver is connected properly and the red LED is flashing and operator is beeping (only in limit set mode) while the green LED of the transmitter is ON, the transmitter and/or receiver are not aligned.
- Make horizontal and/or vertical adjustment on the transmitter and/or receiver until the red LED of the receiver turns steady on and operator stops beeping, indicating alignment (Fig. 6.6.3).
- Blocking the safety beam with an object will cause operator to beep, confirming the Safety beam is functioning correctly.



**WARNING:** When the Safety Beam is fitted, the doorway must be clear of all obstructions and persons at all times. Incorrect location of the safety beams may not give safety protection at all times. Check to make sure that the height of the beam gives maximum protection.

**AVERTISSEMENT:** Lorsque le faisceau de sécurité est en place, le passage doit être dégagé en permanence. Si le faisceau est mal placé, la sécurité ne peut pas être assurée correctement. Assurez-vous que la hauteur du faisceau assure une protection maximale.



**WARNING:** Connect the Safety Beam as per diagram in Fig 6.6.2. Tampering with the Safety Beam could result in serious personal injury and/or property damage and will void the warranty.

**AVERTISSEMENT:** Raccordez le faisceau de sécurité conformément au schéma Fig. 6.2.2. Saboter le faisceau de sécurité présente un risque de blessure corporelle grave et/ou de dommages matériels, et annule la garantie.

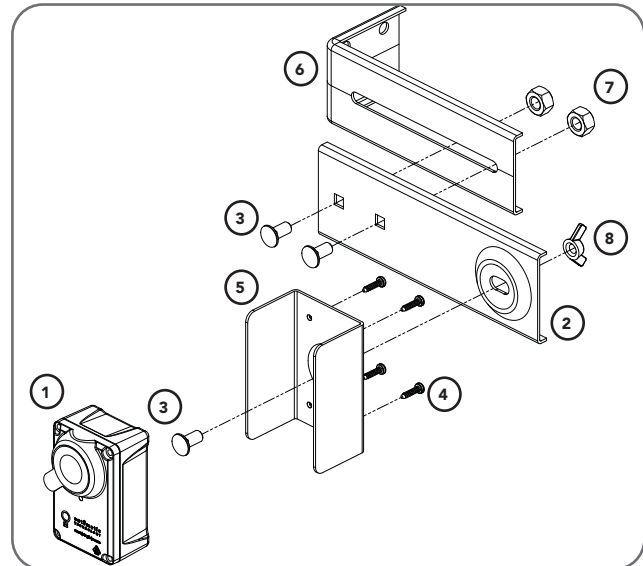

Fig.6.6.1

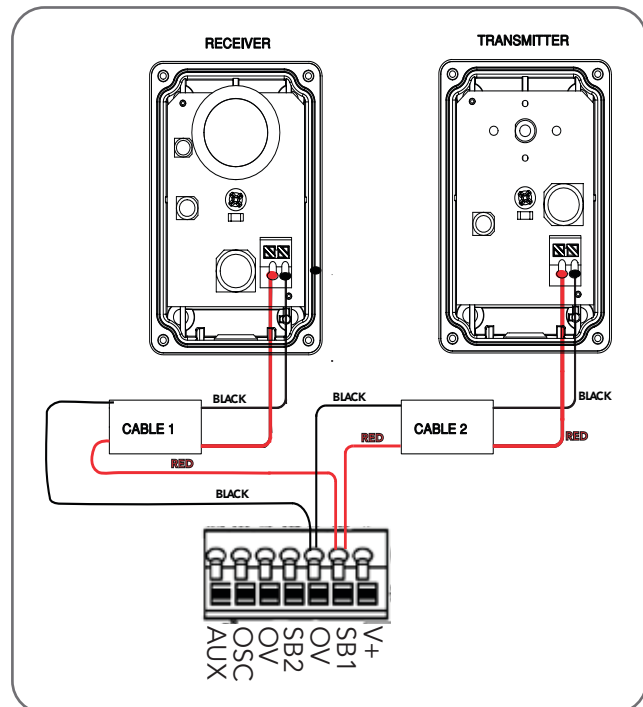

Fig.6.6.2

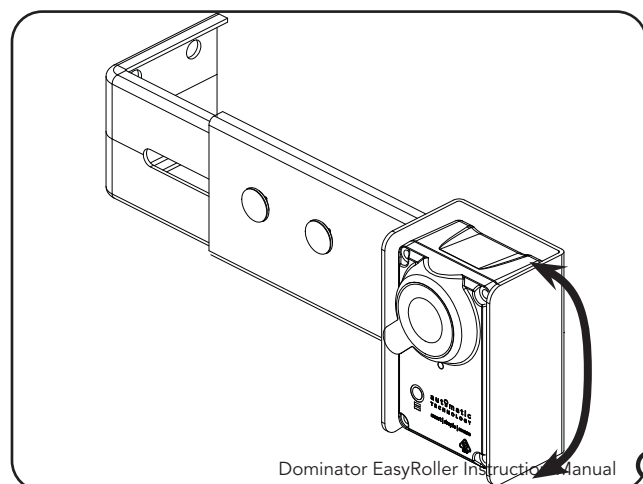

Fig 6.6.3





# 6.7. Setting the Travel Limits

## 6.7.1 Initial Preparation:







When setting the Close limit, ensure the position is when the door makes first contact with the ground. Alternatively for the Open limit the position should be at the height of the garage opening.

**CAUTION:** Limit setup is not available when running on battery backup

STEP ONE		STEP TWO	
Remove controls cover		 Switch power on	
STEP THREE			
If door opens			
 Press to close	 Press to change direction	 Press to move door to midway	

## 6.7.2 Set the Limit Positions:

CLOSE LIMIT POSITION	
STEP ONE	STEP TWO
 Press to close door <b>RELEASE</b>	 When door near close, single presses inch door  CLOSE limit should be when rubber strip touches the ground

OPEN LIMIT POSITION	
STEP ONE	STEP TWO
 Press to open door <b>RELEASE</b>	 When door near open, single presses inch door  OPEN limit should be the height of the garage opening



**WARNING!** In setting the close limit position, do not force the door into the floor with excessive force, as this can interfere with the ease of operation of the manual release mechanism.

**AVERTISSEMENT!** Ne pas forcer la porte contre le sol lors du réglage de fin de course, car une force excessive peut entraver le fonctionnement du système de déclenchement manuel.

**WARNING!** The door will automatically close, open and close again after the next step. Ensure that nothing is in the door's path.

**AVERTISSEMENT!** La porte va se fermer puis s'ouvrir automatiquement, avant de se fermer. S'assurer que rien ne bloque l'ouverture ou la fermeture de la porte.

STEP THREE		
If door overshoots		
 Press	 Press to position	 Press to set

STEP THREE		
If door overshoots		
 Press	 Press to position	 Press to set



# 6.7. Setting the Travel Limits

## 6.7.3 Clearing the Door Limit Positions





**NOTE:** If unhappy with the travel limit setting, restart this procedure by clearing the door limit positions as per below first.

STEP ONE	STEP TWO
Remove controls cover	 →  <b>HOLD for 6 sec</b> Till LED flashes quickly
STEP THREE	
 Release	<p><b>NOTE:</b> No action taken within 30 secs, the opener returns to original settings.</p> <p>Now set Close &amp; Open limits</p>

## 6.7.5 Re-profiling the Door

**tip** Re-profiling is a simple way of re-learning the travel characteristics of a previously setup Limit Switch travel. Re-profiling is used when travel characteristic change due to mechanical adjustments.

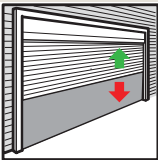

To initiate a re-profile: LIMITS must already be set.

STEP ONE			
Remove controls cover	 →  <b>HOLD for 6 secs</b> opener beeps once		
STEP TWO			
 Door will open and close several times	<th colspan="2">STEP THREE</th>	STEP THREE	
 → Then refit controls cover	opener beeps once		

## 6.7.4 Controller Memory Reset

To clear the controller:





**tip** If limits are already set, clear limits first by following Clearing the door limit positions and then follow below.

STEP ONE	STEP TWO
 Switch power OFF	 →  → till all LED's off then Release
	<b>HOLD</b> Switch power ON

This will cause all control memory to be set to factory defaults EXCLUDING: transmitters, history log and cycle counters.

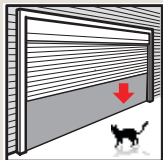



## 6.7.6 Setting the PET Mode position

**tip** When activated, PET mode drives the door to a preset position from the close position, therefore allowing a pet or parcel to go under the door.

STEP ONE	STEP TWO
 →  <b>HOLD</b> Close to desired position	Remove controls cover
STEP THREE	
 →  +  <b>HOLD</b> for 6 secs till both LED's are lit	
STEP FOUR	
 → Refit controls cover → Proceed to Storing the transmitter Code to code a remote button to PET Mode	
Release	

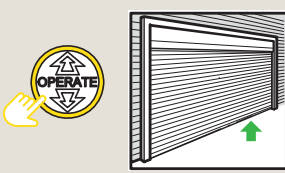
# 6.8 Testing & Setting Safety Obstruction Force

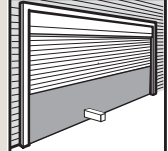
## 6.8.1 Testing the Close Cycle

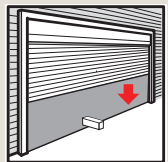
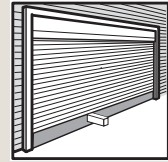
<p><b>STEP ONE</b></p> <p>when the door is closed</p>  <p>Press to open door halfway</p>	<p><b>STEP TWO</b></p>  <p>Press to stop</p>  <p>Place a piece of 2" x 4" timber laid flat in centre of opening</p>
<p><b>STEP THREE</b></p>  <p>Press to close</p> 	<p><b>STEP TWO</b></p>  <p>When door contacts object, the door must STOP and REVERSE!</p>

**IF THE DOOR DOES NOT PROPERLY REVERSE:** Check that the close limit position is where the door touches the ground. If the door STOPS but does not reverse, decrease the force pressure.



**IMPORTANT WARNING!** If the door is closing and is unable to re-open when obstructed, discontinue use. Do not use a door with faulty obstruction sensing. Repair fault and re-test before using.



**AVERTISSEMENT IMPORTANT!** Si la porte est en train de se refermer et ne peut pas être rouverte, arrêtez de l'utiliser. N'utilisez pas une porte dont les détecteurs d'obstacles sont défectueux. Réparez-les et refaites un essai.



**CAUTION:** Take care when testing the safety obstruction force. Excessive force may cause serious personal injury and/or property damage can result from failure to follow this warning.

**ATTENTION:** Testez la résistance aux obstacles avec précaution. Une force excessive présente un risque de blessure corporelle grave et/ou d'endommager le matériel si vous ne respectez pas cet avertissement.

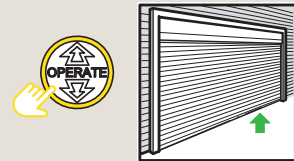
## 6.8.2 Testing the Open Cycle

<p><b>STEP ONE</b></p> <p>when the door is closed</p>  <p>Press to open door</p>	<p><b>STEP TWO</b></p>  <p>When the door reaches halfway, grab the bottom rail firmly. Door should STOP!</p>
--	---

**IF THE DOOR DOES NOT STOP:** The Force pressure may be excessive and need adjusting. Follow steps to decrease force pressure.



# 6.8 Testing & Setting Safety Obstruction Force

## Adjusting Safety Obstruction Force

The safety obstruction force is calculated automatically and set in memory on the operator. It is usually not necessary to adjust the safety obstruction force. The only time the force may need to be increased is due to environmental conditions, for example, windy or dusty areas, and areas with extreme temperature changes.

**! WARNING! Risk of entrapment. After adjusting either the force or limits of travel, retest the door opener. The door MUST reverse on contact with a 1-1/2-inch high object (or a 2 by 4 board laid flat) at the center of doorway on the floor.**

**AVERTISSEMENT! Risque de pincement. Après avoir réglé la force ou les fins de course, refaites un essai du système d'ouverture de porte. La porte doit OBLIGATOIREMENT inverser sa course en cas de contact avec un objet de 25 à 40 mm (1-1/2") (ou une planche de 5 x 10 cm posée à plat) au milieu du passage.**

### 6.8.3 To Increase Force Pressure

**STEP ONE**

Remove controls cover → → + →

**HOLD**

Each press will increase force & LED will flash

**STEP TWO**

If LED keeps flashing, maximum is reached

**STEP THREE**

**RELEASE**

Test the force again as per Testing cycles

### 6.8.4 To Decrease Force Pressure

**STEP ONE**

Remove controls cover → → + →

**HOLD**

Each press will decrease force & LED will flash

**STEP TWO**

If LED keeps flashing, minimum is reached

**STEP THREE**

**RELEASE**

Test the force again as per Testing cycles

### 6.8.5 To Recall Factory Set Force

**STEP ONE**

Remove controls cover → + →

**HOLD for 2 sec**

**RELEASE**

default will be recalled

### 6.8.6 To Re-Profile the Door

**! tip** Re-profiling is a simple way of re-learning the travel characteristics of a previously setup Limit Switch travel. Re-profiling is used when travel characteristic change due to mechanical adjustments.

To initiate a re-profile: LIMITS must already be set.

**STEP ONE**

Remove controls cover → →

**HOLD for 6 secs**

**RELEASE**

opener beeps once

**STEP TWO**

Door will open and close several times

**STEP THREE**

Then refit controls cover

opener beeps once

# 6.9 Accessories

## 6.9.1 Terminal Block

A variety of wired accessory items can be connected to the terminal block **J7** such as Safety Beam, Electric Key Switch and more (**Fig. 6.9.1**).

Terminal connections from top down are as follows:

1. **V+** (+35V/+24V);
2. **EB1** (Safety Beam input, mandatory);
3. **OV** (0V for Safety Beam);
4. **EB2** (Safety Beam input);
5. **OV** (Common ground for accessories and Safety Beam);
6. **OSC** (Open/Stop/Close trigger)
7. **AUX OUT** (Auxiliary output trigger)

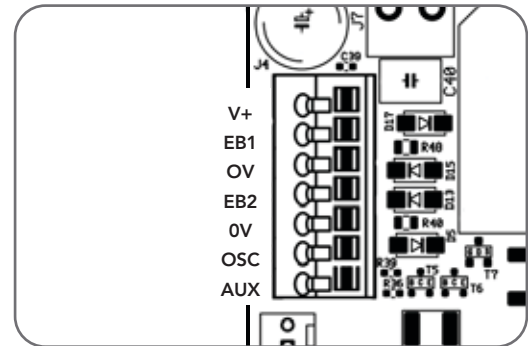
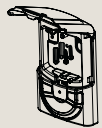

Fig.6.9.1

## 6.9.2 Installation of Wall Mounted Transmitter

### STEP ONE



Remove the mounting hardware from inside cover

### STEP TWO



Pull the battery tab to commission

### STEP THREE

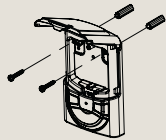

Pre-drill holes, using 6mm drill bits

OR

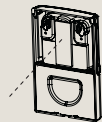

Place velcro on back of cover

Mount at least 1.5m off the ground, and make sure the door is visible from this location. Follow the instructions on how to set transmitter codes in next section.



**ELECTROCUTION!** Be mindful not to drill into existing wiring as this may result in serious harm and or death.

## IMPORTANT WARNING

### LOCATE THE WALL MOUNTED REMOTE CONTROL:

- (1) WITHIN SIGHT OF DOOR.
- (2) AT MINIMUM HEIGHT OF 5 FEET ABOVE FLOORS, LANDINGS, STEPS OR OTHER ADJACENT WALKING SURFACE SO SHALL CHILDREN ARE NOT ABLE TO REACH IT, AND
- (3) AWAY FROM MOVING PARTS OF THE DOOR.
- (4) PLACE THE ATTACHED ENTRAPMENT WARNING LABEL ON WALL NEXT TO WALL MOUNTED TRANSMITTER. USE AN ADDITIONAL MECHANICAL MEANS (PLATE, BOARD, ETC.), WHICH CAN SECURE THE LABELS TO SURFACES TO WHICH THE ADHESIVE WILL NOT ADHERE.
- (5) DO NOT REMOVE OR PAINT OVER THIS LABEL.

## IMPORTANT

### PLACEZ LA TÉLÉCOMMANDE MURALE :

- (1) EN VUE DE LA PORTE.
- (2) À UNE HAUTEUR D'AU MOINS 1,50 M (5 PIEDS) AU-DESSUS DU SOL, DU PERRON, DES MARCHES, ETC. AFIN QUE LES PETITS ENFANTS NE PUISSENT PAS L'ATTEINDRE,
- (3) ET À DISTANCE DES ÉLÉMENTS MOBILES DE LA PORTE.
- (4) PLACEZ L'ÉTIQUETTE AVERTISSANT DU RISQUE DE SE FAIRE PIÉGER SUR LE MUR À PROXIMITÉ DE L'ÉMETTEUR. UTILISEZ UN SUPPORT PHYSIQUE SUPPLÉMENTAIRE (PLAQUE, PANNEAU, ETC.) PERMETTANT DE FIXER LES ÉTIQUETTES SI ELLES N'ADHÈRENT PAS À LA SURFACE DU MUR.
- (5) CETTE ÉTIQUETTE NE DOIT PAS ÊTRE RETIRÉE NI PEINTE.

# 6.10 Coding Transmitters

## TRANSMITTERS COMPLIANCE STATEMENT

TRANSMITTERS COMPLY WITH ALL UNITED STATES AND CANADIAN LEGAL REQUIREMENTS AS OF THE DATE OF MANUFACTURE. TO COMPLY WITH **FCC PART 15** AND OR **RSS 210 INNOVATION, SCIENCE AND ECONOMIC DEVELOPMENT CANADA** RULES, ADJUSTMENT OR MODIFICATIONS OF THIS RECEIVER AND / OR TRANSMITTER ARE PROHIBITED, EXCEPT FOR CHANGING THE CODE SETTING OR REPLACING THE BATTERY. THERE ARE NO OTHER USER SERVICEABLE PARTS. TESTED TO COMPLY WITH FCC STANDARD FOR HOME OR OFFICE USE. THIS DEVICE CONTAINS LICENCE-EXEMPT TRANSMITTER(S)/RECEIVER(S) THAT COMPLY WITH INNOVATION, SCIENCE AND ECONOMIC DEVELOPMENT CANADA'S LICENCE-EXEMPT RSS(S). OPERATION IS SUBJECT TO THE FOLLOWING TWO CONDITIONS:

(1) THIS DEVICE MAY NOT CAUSE INTERFERENCE.

(2) THIS DEVICE MUST ACCEPT ANY INTERFERENCE, INCLUDING INTERFERENCE THAT MAY CAUSE UNDESIRE OPERATION OF THE DEVICE.

**NOTE:** THIS EQUIPMENT HAS BEEN TESTED AND FOUND TO COMPLY WITH THE LIMITS FOR A CLASS B DIGITAL DEVICE, PURSUANT TO PART 15 OF THE FCC RULES. THESE LIMITS ARE DESIGNED TO PROVIDE REASONABLE PROTECTION AGAINST HARMFUL INTERFERENCE IN A RESIDENTIAL INSTALLATION. THIS EQUIPMENT GENERATES, USES AND CAN RADIATE RADIO FREQUENCY ENERGY AND, IF NOT INSTALLED AND USED IN ACCORDANCE WITH THE INSTRUCTIONS, MAY CAUSE HARMFUL INTERFERENCE TO RADIO COMMUNICATIONS. HOWEVER, THERE IS NO GUARANTEE THAT INTERFERENCE WILL NOT OCCUR IN A PARTICULAR INSTALLATION. IF THIS EQUIPMENT DOES CAUSE HARMFUL INTERFERENCE TO RADIO OR TELEVISION RECEPTION, WHICH CAN BE DETERMINED BY TURNING THE EQUIPMENT OFF AND ON, THE USER IS ENCOURAGED TO TRY TO CORRECT THE INTERFERENCE BY ONE OR MORE OF THE FOLLOWING MEASURES:

- REORIENT OR RELOCATE THE RECEIVING ANTENNA
- INCREASE THE SEPARATION BETWEEN THE EQUIPMENT AND RECEIVER
- CONNECT THE EQUIPMENT INTO AN OUTLET ON A CIRCUIT DIFFERENT FROM THAT TO WHICH THE RECEIVER IS CONNECTED. CONSULT YOUR LOCAL DEALER OR AN EXPERIENCED RADIO/TV TECHNICIAN FOR HELP.

## DÉCLARATION DE CONFORMITÉ DE L'ÉMETTEUR

LES ÉMETTEURS SONT CONFORMES À TOUTES LES EXIGENCES LÉGALES DES ÉTATS-UNIS ET DU CANADA À LA DATE DE FABRICATION. POUR SE CONFORMER AUX RÈGLES **D'INNOVATION, SCIENCE ET DÉVELOPPEMENT ÉCONOMIQUE CANADA PARTIE 15 ET OU RSS 210 DE FAC**. LES RÉGLAGES OU MODIFICATIONS DE CE RÉCEPTEUR ET/OU ÉMETTEUR SONT INTERDITS, À L'EXCEPTION DU CHANGEMENT DE CODE OU DU REMPLACEMENT DE LA BATTERIE. AUCUNE AUTRE PIÈCE NE PEUT ÊTRE RÉPARÉE PAR L'UTILISATEUR. CONFORMITÉ À LA NORME FCC TESTÉE POUR UN USAGE DOMESTIQUE OU DE BUREAU. L'ÉMETTEUR/RÉCEPTEUR EXEMPT DE LICENCE CONTENU DANS LE PRÉSENT APPAREIL EST CONFORME AUX CNR D'INNOVATION, SCIENCES ET DÉVELOPPEMENT ÉCONOMIQUE CANADA APPLICABLES AUX APPAREILS RADIO EXEMPTS DE LICENCE. L'EXPLOITATION EST AUTORISÉE AUX DEUX CONDITIONS SUIVANTES :

L'APPAREIL NE DOIT PAS PRODUIRE DE BROUILLAGE ;

L'APPAREIL DOIT ACCEPTER TOUT BROUILLAGE RADIOÉLECTRIQUE SUBI, MÊME SI LE BROUILLAGE EST SUSCEPTIBLE D'EN COMPROMETTRE LE FONCTIONNEMENT.



**REMARQUE:** CET ÉQUIPEMENT A ÉTÉ TESTÉ ET DÉCLARÉ CONFORME AUX LIMITATIONS APPLICABLES À UN APPAREIL NUMÉRIQUE DE CLASSE B, CONFORMÉMENT AUX DISPOSITIONS DE LA PARTIE 15 DES RÈGLES DE LA FCC. CES LIMITATIONS VISENT À ASSURER UNE PROTECTION SUFFISANTE CONTRE LES INTERFÉRENCES DANS UNE INSTALLATION RÉSIDENIELLE. CET ÉQUIPEMENT DÉGAGE, UTILISE ET PEUT DIFFUSER DES ONDES RADIO. S'IL N'EST PAS INSTALLÉ ET UTILISÉ CONFORMÉMENT AUX INSTRUCTIONS, LES INTERFÉRENCES PEUVENT PERTURBER LES COMMUNICATIONS RADIO. IL N'Y A TOUTEFOIS AUCUNE GARANTIE QUE DES INTERFÉRENCES NE SE PRODUIRONT PAS DANS UNE INSTALLATION DONNÉE. SI CET ÉQUIPEMENT VIENT À CAUSER DES INTERFÉRENCES AVEC LA RÉCEPTION DE LA RADIO OU DE LA TÉLÉVISION, CE QUI PEUT ÊTRE DÉTERMINÉ EN L'ÉTEIGNANT ET EN LE RALLUMANT, L'UTILISATEUR EST INVITÉ À Y REMÉDIER EN PRENANT UNE OU PLUSIEURS DES MESURES SUIVANTES :

- RÉORIENTER OU DÉPLACER L'ANTENNE DE RÉCEPTION ;
- ÉLOIGNER L'ÉQUIPEMENT DU RÉCEPTEUR ;
- BRANCHER L'ÉQUIPEMENT DANS UNE PRISE DE COURANT D'UN CIRCUIT ÉLECTRIQUE DIFFÉRENT. LE CAS ÉCHÉANT, CONSULTEZ VOTRE REVENEUR OU UN TECHNICIEN RADIO/TV EXPÉRIMENTÉ.

# 6.10 Coding Transmitters

## 6.10.1 Setting Transmitters Codes

**tip** The opener can only be operated from remote controllers that have been programmed into its memory. Up to 64 remotes can be programmed.





STEP ONE	STEP TWO
 <p><b>HOLD</b> Opener beeps</p>  <p><b>HOLD for 3 sec</b> <b>RELEASE</b> <b>HOLD for 3 sec</b> Release both buttons</p>	 <p>Press to test</p>

**WARNING!** The manufacturer is not responsible for any radio or TV interference caused by unauthorized modifications to this equipment. Such modifications could void the user's authority to operate the equipment.

**AVERTISSEMENT!** Le fabricant n'est pas responsable des éventuelles interférences avec la réception de la radio ou de la TV due à une modification de cet équipement effectuée sans autorisation. De telles modifications peuvent invalider le droit à utiliser l'équipement.

## 6.10.2 Remotely Coding Transmitters





**tip** Remotely coding works when you have a pre-coded remote control and are in range of the opener.

STEP ONE	STEP TWO
 <p>Take a pre-coded remote and press the button to duplicate</p>	 <p>Use a pen, <b>HOLD for 2 sec</b> the middle button through the coding hole</p>
STEP THREE	STEP FOUR
<p>Opener flashes &amp; beeps</p>  <p>Take new remote</p> <p><b>HOLD for 3 sec</b> <b>RELEASE</b> <b>HOLD for 3 sec</b> <b>RELEASE</b></p>	<p>Opener stops flashing &amp; beeping</p>  <p>Press to test</p>





**tip** Remote code set is disabled when:

- powered by battery backup
- the service indicator is active
- when the door is indicating that it as prevented from closing by a P.E beam being blocked.

## 6.10.3 Coding for Vacation Mode







STEP ONE	STEP TWO
Remove controls cover	 <p>Press once</p>
STEP THREE	
 <p><b>HOLD</b> Opener beeps 2 times</p>	 <p><b>HOLD for 3 sec</b> <b>RELEASE</b> <b>HOLD for 3 sec</b> Release all buttons</p>
STEP FOUR	STEP FIVE
Then refit controls cover	<p>Turn on      Turn off</p>  <p><b>HOLD for 4 sec</b> <b>RELEASE</b></p> <p>Press, then try another remote</p>

## 6.10.4 Coding for AUX Output

STEP ONE	STEP TWO
Remove controls cover	 <p>Press twice</p>
STEP THREE	
 <p><b>HOLD</b> Opener beeps 3 times</p>	 <p><b>HOLD for 3 sec</b> <b>RELEASE</b> <b>HOLD for 3 sec</b> Release all buttons</p>
STEP FOUR	STEP FIVE
Then refit controls cover	 <p>Press to test</p>

# 6.10 Coding Transmitters





## 6.10.5 Coding for PET (Pedestrian) Mode

<b>STEP ONE</b>	<b>STEP TWO</b>
Remove controls cover	 Press three times
<b>STEP THREE</b>	
 +  >  <b>HOLD</b> Opener beeps 4 times	 <b>HOLD for 3 sec</b> <b>RELEASE</b> <b>HOLD for 3 sec</b> Release all buttons
<b>STEP FOUR</b>	<b>STEP FIVE</b>
Then refit controls cover	 Press to test









## 6.10.6 Coding for Courtesy Light

<b>STEP ONE</b>	
 <b>HOLD</b> Opener beeps	 <b>HOLD for 3 sec</b> <b>RELEASE</b> <b>HOLD for 3 sec</b> Release all buttons
<b>STEP TWO</b>	<b>STEP THREE</b>
 Release	 Press to test

## 6.10.7 Erasing a Stored Transmitter Code

<b>STEP ONE</b>	<b>STEP TWO</b>
Remove controls cover	 Select the transmitter button to delete
<b>STEP THREE</b>	<b>STEP FOUR</b>
 >  <b>HOLD</b> Opener beeps <b>HOLD for 3 sec</b> <b>RELEASE</b> <b>HOLD for 3 sec</b> Release all buttons	Button deleted  Test by pressing the button Refit controls cover

## 6.10.8 Erasing ALL Transmitter Codes

<b>STEP ONE</b>	<b>STEP TWO</b>
Remove controls cover  Switch power OFF	 >  <b>HOLD</b> Turn power ON
<b>STEP THREE</b>	
 +  + 	
These LED's will illuminate for 5 secs then go out	
<b>STEP FOUR</b>	<b>STEP FIVE</b>
 Release button when light turns on	ALL stored codes deleted  Test by pressing a remote Refit controls cover

# 6.11 Auto-Close

## 6.11.1 Safety Beams

A Safety Beam Kit may be fitted to this opener. When this option is fitted, the operation of this device is such that if an object (i.e car, child etc) blocks the Infra-Red beam, then the garage door opener will not close the door automatically. If the Safety Beam is fitted but not operating correctly, then the door once opened automatically, will not close automatically.

## 6.11.2 Auto Close Option

Auto-Close mode is a function that automatically closes the door a preset time after the Safety Beams recognise that a vehicle has left the garage. The Auto-Close timer only starts after the Safety Beam's path is broken. If the safety beam path is not broken, the door will remain open until the path is broken. If the opener incurs a physical obstruction (i.e. not from the Safety Beams) while closing the door, it will re-open and not Auto-Close until the Safety Beam's path is broken again.

**TO ENABLE THE AUTO-CLOSE FUNCTION**

**STEP ONE**

Remove controls cover



To change delay time



OR



Each press will add 1 sec

Each press will remove 1 sec

**STEP TWO**

Press to open the door

**STEP THREE**

LED will flash to indicate Auto-Close operational

break the safety beam path to initialise Auto-Close

**WARNING! It is compulsory to have Safety Beams installed when using Auto-Close mode.**

**AVERTISSEMENT! Le faisceau de sécurité doit être installé lorsque vous utilisez le mode Auto-Close.**

# 6.12 Attach Warning Labels / Placards

## 6.12.1 Placement of Warning Labels / Placards

- Attach the entrapment warning label (Residential) OR placard (Commercial) on the wall near the door control with tacks or staples at a minimum height of 5 feet above floors, landings, steps or other adjacent walking surface so shall children are not able to reach it.
- **DO NOT REMOVE OR PAINT OVER THIS PLACARD.**
- **NE PAS ENLEVER CETTE ÉTIQUETTE NI LA COUVRIR DE PANNEAU**

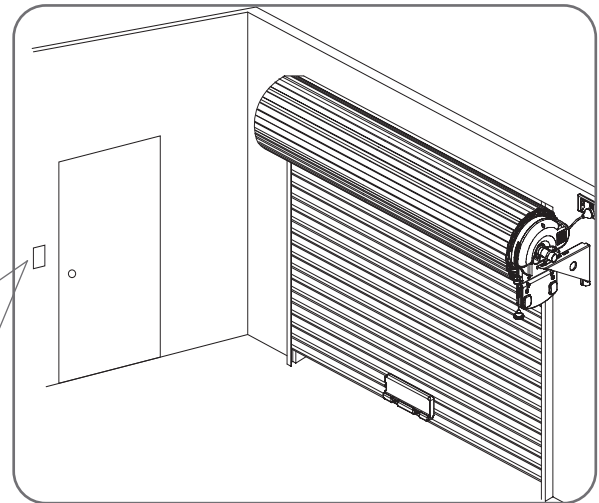

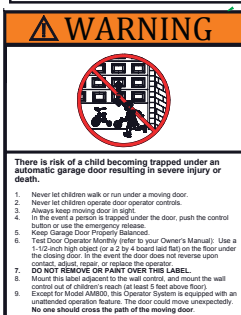



Fig.6.11.1

Residential Labels

Commercial Placards

# 7. Operation Instructions

## IMPORTANT SAFETY INSTRUCTIONS WARNING! TO REDUCE THE RISK OF SEVERE INJURY OR DEATH:

- (1) **READ AND FOLLOW ALL INSTALLATION INSTRUCTIONS.**
- (2) NEVER LET CHILDREN OPERATE OR PLAY WITH DOOR CONTROLS. KEEP THE REMOTE CONTROL AWAY FROM CHILDREN.
- (3) ALWAYS KEEP THE MOVING DOOR IN SIGHT AND AWAY FROM PEOPLE AND OBJECTS UNTIL IT IS COMPLETELY CLOSED. NO ONE SHOULD CROSS THE PATH OF THE MOVING DOOR.
- (4) **NEVER GO UNDER A STOPPED, PARTIALLY OPEN DOOR.**
- (5) TEST DOOR OPENER MONTHLY. THE GARAGE DOOR **MUST** REVERSE ON CONTACT WITH A 1-1/2-INCH HIGH OBJECT (OR A 2 BY 4 BOARD LAID FLAT) ON THE FLOOR. AFTER ADJUSTING EITHER THE FORCE OR THE LIMIT OF TRAVEL, RETEST THE DOOR OPENER. FAILURE TO ADJUST THE OPENER PROPERLY INCREASES THE RISK OF SEVERE INJURY OR DEATH.
- (6) FOR PRODUCTS HAVING AN EMERGENCY RELEASE, WHEN POSSIBLE, USE THE EMERGENCY RELEASE ONLY WHEN THE DOOR IS CLOSED. USE CAUTION WHEN USING THIS RELEASE WITH THE DOOR OPEN. WEAK OR BROKEN SPRINGS ARE CAPABLE OF INCREASING THE RATE OF DOOR CLOSURE AND INCREASING THE RISK OF SEVERE INJURY OR DEATH.
- (7) **KEEP GARAGE DOORS PROPERLY BALANCED.** SEE OWNER'S MANUAL. AN IMPROPERLY BALANCED DOOR INCREASES THE RISK OF SEVERE INJURY OR DEATH. HAVE A QUALIFIED SERVICE PERSON MAKE REPAIRS TO CABLES, SPRING ASSEMBLIES, AND OTHER HARDWARE.
- (8) THIS PRODUCT CONTAINS A LITHIUM BUTTON/COIN CELL BATTERY. IF A NEW OR USED LITHIUM BUTTON/COIN CELL BATTERY IS SWALLOWED OR ENTERS THE BODY, IT CAN CAUSE SEVERE INTERNAL BURNS AND CAN LEAD TO DEATH IN AS LITTLE AS 2 HOURS. ALWAYS COMPLETELY SECURE THE BATTERY COMPARTMENT. IF THE BATTERY COMPARTMENT DOES NOT CLOSE SECURELY, STOP USING THE PRODUCT, REMOVE THE BATTERIES, AND KEEP IT AWAY FROM CHILDREN. IF YOU THINK BATTERIES MIGHT HAVE BEEN SWALLOWED OR PLACED INSIDE ANY PART OF THE BODY, **SEEK IMMEDIATE MEDICAL ATTENTION.**

### (9) SAVE THESE INSTRUCTIONS.

## AVERTISSEMENT !

### POUR RÉDUIRE LE RISQUE DE BLESSURES GRAVES, VOIRE DE MORT:

- (1) **LISEZ ATTENTIVEMENT TOUTES LES INSTRUCTIONS D'INSTALLATION.**
- (2) NE LAISSEZ JAMAIS LES ENFANTS UTILISER LES COMMANDES DE LA PORTE OU JOUER AVEC. LA TÉLÉCOMMANDE DOIT RESTER HORS DE PORTÉE DES ENFANTS.
- (3) GARDEZ TOUJOURS LA PORTE EN MOUVEMENT DANS VOTRE LIGNE DE VISION, ET VEILLES À CE QU'ELLE RESTE ENTIÈREMENT DÉGAGÉE JUSQU'À SA FERMETURE COMPLÈTE. PERSONNE NE DOIT SE TENIR DANS LE PASSAGE PENDANT QUE LA PORTE EST EN MOUVEMENT.
- (4) **NE STATIONNEZ JAMAIS SOUS UNE PORTE PARTIELLEMENT OUVERTE.**
- (5) TESTEZ LE DISPOSITIF D'OUVERTURE UNE FOIS PAR MOIS. LA PORTE DOIT **OBLIGATOIREMENT** INVERSER SA COURSE EN CAS DE CONTACT AVEC UN OBJET DE 25 À 40 MM (1-1/2") (OU UNE PLANCHE DE 5 X 10 CM [2X4"] POSÉE À PLAT) AU MILIEU DU PASSAGE. APRÈS AVOIR RÉGLÉ LA FORCE OU LA LIMITE DE COURSE, REFAITES UN ESSAI DU SYSTÈME D'OUVERTURE DE PORTE. LE DISPOSITIF D'OUVERTURE DOIT ÊTRE BIEN RÉGLÉ AFIN DE RÉDUIRE LE RISQUE DE BLESSURES GRAVES, VOIRE DE MORT.
- (6) DANS LE CAS DES PRODUITS ÉQUIPÉS D'UN DÉBLOCAGE D'URGENCE, UTILISEZ-LE DANS LA MESURE DU POSSIBLE UNIQUEMENT QUAND LA PORTE EST FERMÉE. SOYEZ PRUDENT SI VOUS ACTIONNEZ CE DISPOSITIF DE DÉBLOCAGE ALORS QUE LA PORTE EST OUVERTE. DES RESSORTS FAIBLES OU CASSÉS RISQUENT D'ACCÉLÉRER LA FERMETURE DE LA PORTE ET DE CAUSER DES BLESSURES GRAVES, VOIRE DE PRÉSENTER UN DANGER DE MORT.
- (7) **LES PORTES DE GARAGE DOIVENT TOUJOURS ÊTRE CORRECTEMENT ÉQUILIBRÉES.** REPORTEZ-VOUS AU MANUEL. UNE PORTE MAL ÉQUILIBRÉE PRÉSENTE UN DANGER DE BLESSURES GRAVES, VOIRE DE MORT. LES RÉPARATIONS DES CÂBLES, DES ASSEMBLAGES À RESSORT ET AUTRES ÉLÉMENTS MATÉRIELS DOIVENT ÊTRE EFFECTUÉES PAR UN TECHNICIEN QUALIFIÉ.
- (8) CE PRODUIT CONTIENT UNE PILE BOUTON/MONNAIE AU LITHIUM. SI UNE PILE BOUTON/MONNAIE AU LITHIUM NEUVE OU USAGÉE EST AVALÉE OU PÉNÈTRE DANS LE CORPS, ELLE PEUT CAUSER DE GRAVES BRÛLURES INTERNES ET PEUT ENTRAÎNER LA MORT EN DEUX HEURES SEULEMENT. TOUJOURS SÉCURISER COMPLÈTEMENT LE COMPARTIMENT DES PILES. SI LE COMPARTIMENT DES PILES NE SE FERME PAS CORRECTEMENT, ARRÊTEZ D'UTILISER LE PRODUIT, RETIREZ LES PILES ET GARDEZ-LE HORS DE PORTÉE DES ENFANTS. SI VOUS PENSEZ QUE DES PILES ONT PU ÊTRE AVALÉES OU PLACÉES DANS UNE PARTIE QUELCONQUE DU CORPS, **CONSULTEZ IMMÉDIATEMENT UN MÉDECIN.**

### (9) CONSERVEZ CES INSTRUCTIONS EN LIEU SÛR.

# 7.1 How to Use Your Operator

For maximum efficiency of your operator, your garage door must be in good operating condition. An annual service of your garage door by door professional is recommended.

**CAUTION:** Activate the operator only when the door is in full view, free of obstructions and with the operator properly adjusted. No one should enter or leave the garage while the door is in motion. Do not allow children to play near the door.

**ATTENTION:** Activez le dispositif de commande uniquement lorsque la porte est en pleine vue, dégagée et avec le dispositif correctement réglé. Personne ne doit entrer ou sortir du garage pendant que la porte est en mouvement. Ne pas laisser les enfants jouer près de la porte.

**WARNING!** This operator has a grounding type plug and there are no user serviceable parts inside this operator.

**AVERTISSEMENT!** Ce dispositif de commande est pourvu d'une broche de mise à la terre et ne comporte aucune pièce réparable par l'utilisateur.

## 7.1.1 To Operate the opener:

- Press the programmed transmitter button until your door begins to move (usually 2 seconds). Make sure you can see the door when you use the transmitter (**Fig 7.1.1**).
- If you are in a vehicle you should aim the transmitter through your windscreen as shown.
- Check that the door is fully open or closed before you drive in or away.
- If you press the transmitter whilst the door is moving the door will stop. The next press of the transmitter will move the door in the opposite direction.

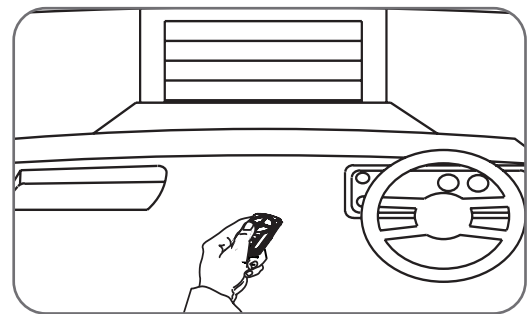

Fig.7.1.1

## 7.1.2 Replacing the Battery: 3V Lithium Battery CR2032.

### BATTERY IN PREMIUM REMOTE CONTROL

**tip** Battery Type: 1 x CR2032.

STEP ONE	Light Status	Battery
<p>Check Light Status Table</p> <p><b>HOLD</b></p>	Solid	OK
	Flashing	Replace
	No light	Replace

STEP TWO	STEP THREE
<p>Use screwdriver to remove screws and open</p>	<p>Use non-metallic object to push out.</p>

### BATTERY IN WALL MOUNTED TRANSMITTER

**tip** Battery Type: 1 x CR2032.

STEP ONE	Light Status	Battery
<p>Check Light Status Table</p> <p><b>HOLD</b></p>	Solid	OK
	Flashing	Replace
	No light	Replace

STEP TWO	STEP THREE
<p>lift lid, slide up &amp; off screws</p> <p>OR</p> <p>peel off from velcro</p>	<p>Use pen to lift lid, then push and release battery</p>

Replace battery and remount to wall.  
Dispose of battery responsibly

**WARNING!** Chemical Burn Hazard. Keep batteries away from children

**AVERTISSEMENT!** Risque de brûlure chimique: Gardez les piles hors de portée des enfants.

**WARNING!** The Battery shall be disposed of properly, including keeping them away from children. Even used batteries may cause injury.

**AVERTISSEMENT!** La batterie doit être mise au rebut de manière appropriée, notamment en la gardant hors de portée des enfants. Même les piles usées peuvent provoquer des blessures.



## 7.2 User Operating Controls

Button	Function
1. OPERATE	Opens/stops/closes the door
2. CODING LED (Red)	Flashes when a code is being stored or when the transmitter button is pressed
3. LIGHT CODE (White)	Is used for storing or erasing the transmitter button (code) you wish to use to switch the courtesy light on the opener on or off.
4. DOOR CODE (Blue)	Is used for storing or erasing transmitter buttons for door operation
5. OPEN LED (Green)	Illuminates and flashes as the door opens and remains on when the open limit position has been reached.
6. DOOR STATUS LED (Yellow)	Illuminates when Service is due.
7. CLOSE LED (Red)	Illuminates and flashes as the door opens closes, and remains on when the close limit position has been reached.

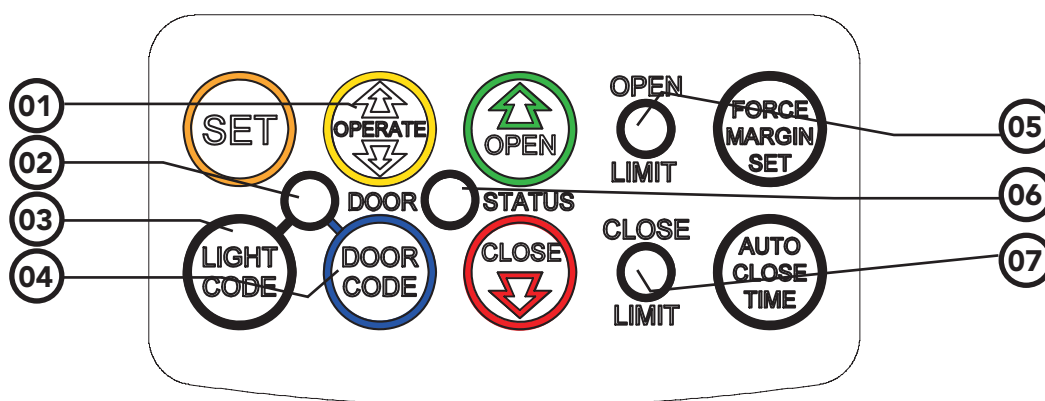

## 7.3. Door Status Indicators

Door Status Indicators	OPEN LED (green)	CLOSE LED (red)	Beeper
Open	On		
Close		On	
Opening	Flashing		
Closing		Flashing	
Door travel stopped	Flashing	Flashing	
Door obstructed when opening	Flashing		Beeps while door is moving
Door obstructed when closing		Flashing	Beeps while door is moving
Opener overloaded	Alternating flashes	Alternating flashes	
Door in open position with Auto-Close mode selected	One second flashes		
Mains power interrupted	Rapid flashes		

# 8. Troubleshooting

Symptom	Possible cause	Remedy
The opener does not work from the transmitter	Garage door in poor condition e.g. springs may be broken	Check the door's operation
	The opener does not have power	Plug a device of similar voltage (e.g. a hairdryer) into the power point and check that it is OK
	The battery in the transmitter is flat	Replace the battery
	Transmitter does not contain TrioCode™ 128 Technology	Check that the transmitter has grey buttons and the model number on the back displays V2. Contact dealer for support if otherwise.
	The opener has been put into "Vacation Mode"	Turn off "Vacation Mode" (Section 11.4)
	The transmitter button is not programmed to operate the door.	Code in the transmitter
One transmitter works but the other/s do not	Door Code LED is flashing yet the opener is not working.	Ensure the correct button on the transmitter is being pressed.
	Faulty transmitter	Replace transmitter
Motor is running but chain is not moving	Flat battery	Replace battery
	Damage motor assembly	Contact your dealer for support.
The transmitter range varies or is restricted	Variations are normal depending on conditions e.g. temperature or external interference	Make sure you can see the door when you use the transmitter.
	The battery life is exhausted	Check the battery status by pressing a button (flashing or no light requires battery to be changed)
	Position of the transmitter in the motor vehicle	Aim the transmitter through the windscreen.
The Courtesy light does not work	LED has failed	Change LED.
The door reverses for no apparent reason	This may occur occasionally from environmental conditions such as areas that are windy, dusty or have extreme temperature changes.	Ensure the door runs smoothly before increasing the force pressure.
	If Safety beams are installed they may be partially obstructed.	Ensure the beam path is not obstructed. Check the Alignment.
Auto Close not working	Safety Beam or wiring faulty	Repair Safety Beam or replace wiring. Re-align optics. See Safety Beam instructions.
The door stops or moves very slowly under battery (Optional Battery Back Up Accessory)	The batteries may have little OR no charge	Connect mains power and leave the batteries to charge. The batteries may take 24 to 48 hours to reach their maximum charge capacity.
The SERVICE LED has started to flash and is beeping numerous times	A Fault has been detected. The fault will be active each time an attempt is made to operate the door.	Record opener function (How many beeps?) then press the SET button once to reset the opener. If the fault continues to be tripped contact your dealer for support.
The Open (Green) LED and Close (Red) LED are flashing alternatively	Opener is overloaded	Check the doors operation by disengaging the motor and ensuring the door runs smoothly. If necessary make door adjustments or contact your door professional.
The Open (Green) LED continues to flash	Door obstructed when opening	Clear away any obstructions and test door opens correctly. (If door is damaged, contact your door professional).
The Close (Red) LED continues to flash	Door obstructed when closing	Clear away any obstructions and test door closes correctly. (If door is damaged, contact your door professional).
	Limits may be cleared	Remove all power sources (including the battery backup). Wait till all lights are out (10-15 secs), then reconnect power. If Red LED is flashing, limits are not set. Reset Limits.

# 9. User Maintenance Instruction



**WARNING!** Run the Safety Testing procedures **MONTHLY** in Section 6.8 to ensure garage door is fit for use.

**AVERTISSEMENT!** Appliquez les procédures de test de la section 6.8 **UNE FOIS PAR MOIS** pour vous assurer que la porte est en état de marche.



**CAUTION:** Frequently examine the installation, in particular cables, springs and mountings, for signs of wear, damage or imbalance. **DO NOT USE** if repair or adjustment is needed since a fault in the installation or an incorrectly balanced door may cause injury.

Adjustments should only be carried out by experienced persons, as this function can be dangerous if not performed under strict safety procedures.

**ATTENTION:** Examinez fréquemment l'installation, en particulier les câbles, les ressorts et les supports, afin de déceler les éventuels signes d'usure, de dommage ou de déséquilibre. **NE PAS utiliser** si la réparation ou un réglage est nécessaire, car un défaut dans l'installation ou une porte mal équilibrée peut causer des blessures.

Les réglages ajustements ne doivent être effectués que par des techniciens expérimentés, car cette fonction peut être dangereuse si elle n'est pas effectuée dans le strict respect des procédures de sécurité.

## 9.1 Door Maintenance

A poorly maintained door could cause fatal / serious injuries or damage to property.

- a. Frequently examine the door, particularly the cables, springs and mountings for signs of wear, damage or imbalance. **DO NOT USE** if repair or adjustment is needed since a fault in the installation or an incorrectly balanced door may cause injury.
- b. Fasteners: Check all screws, nuts and bolts to ensure they are secure.
- c. Spring Tension: It is natural for springs to lose tension. Should the door become hard to operate or completely inoperative, contact a door professional.
- d. Guide Tracks: Clean the internal sections of the guide tracks every 3 - 6 months with a cloth dampened with mineral turps or methylated spirits.

## 9.2 If You Need a Service Call

If the opener needs a service please call the dealer who installed the garage door opener (their contact details are usually on a sticker on the back of your garage door).

**BEFORE CALLING** you should have the following information to assist in providing the appropriate service:

1. Has anything happened since the opener last operated OK, e.g. a storm, a jolt to the door etc.?
2. What is the current light status on the opener?
3. Manually disengage the door (Section 5).  
How easy is it to manually open and close the door?
4. What model is the opener? (Model no. information is located at the rear of the opener)
5. Who installed the opener? (Dealer details should be on a sticker on the back of your garage door)
6. When was it installed? (If known)



**WARNING!** Failure to maintain your garage door may void the warranty on your garage door operator.

**AVERTISSEMENT!** L'absence d'entretien votre porte de garage peut annuler la garantie de votre dispositif d'ouverture.

