



INSTALLATION AND OWNER'S MANUAL

MODEL D-SBG

Single Arm Barrier Gate Operator

UL 325 and UL 991 Listed



Serial #:
Date Installed:
Your Dealer:

READ THIS MANUAL CAREFULLY
BEFORE INSTALLATION OR USE.
SAVE THESE INSTRUCTIONS.



Table of Contents

Model D-SBG Single Arm Barrier Gate Operator

Important Safety Information	3
Important Notice for Gate Operators Manufactured after 1/11/16	4
System Designer Safety Instructions.....	5
Installer Safety Instructions	6-7
End User Safety Warnings	8-9
Manual Operation	11
Safety Warnings	12

Installation & Setup Procedure

Before Installing Operator	10
Installation of Cement Pad.....	11
Installation of Operator	12-13
SBG Pipe Arm Assembly	14
Installation of Barrier Arms.....	15-16
Electrical Connections	17
Manual Operation	18
Limit Adjustment	18-19
Auxiliary Limit Switch	20

Safety Device Connections

Installation of Edge Sensor or Photo Eyes	20
-------------------------------------------------	----

Accessory Connections

Loop Detector Systems	21
Loop Installation (Standard Layout Chart)	22
Cutting the Required Groove	22

PowerMaster Controller Instructions	24
--------------------------------------------------	-----------

Warranty	39
----------------	----

IMPORTANT!

SAFETY IS EVERYONE'S BUSINESS.

Automatic gate operators provide convenience and security to users. However, because these machines can produce high levels of force, it is important that all gate operator system designers, installers, and end users be aware of the potential hazards associated with improperly designed, installed, or maintained systems. Keep in mind that the gate operator is a component part of a total gate operating system.

The following information contains various safety precautions and warnings for the system designer, installer and end user. These instructions provide an overview of the importance of safe design, installation, and use.

Warnings are identified with the ▲ symbol. This symbol will identify some of the conditions that can result in serious injury or death. Take time to carefully read and follow these precautions and other important information provided to help ensure safe system design, installation and use.

▲ WARNING: Gate operators are only one part of a total gate operating system. It is the responsibility of purchaser, designer, and installer to ensure that the total system is safe for its intended use. All secondary entrapment safety devices must be **RECOGNIZED BY UL** to ensure the safety of the complete operating system.

IMPORTANT NOTICE FOR GATE OPERATORS MANUFACTURED AFTER JANUARY 11TH, 2016

All gate operators manufactured after January 11th, 2016 must have a monitored input for each direction. In order to satisfy this requirement, all PowerMaster Swing & Slide Gate Operators will have one monitored input for each direction: The close obstruction (C-OBS) terminal for the close direction and the open obstruction (O-OBS) terminal for the open direction. These terminals will look for, or “monitor” the presence of a 10k inline resistor. If either terminal does not detect the presence of the monitored device the unit will function in constant contact for this direction.

E.g. The operator detects there is a monitored device on the C-OBS terminal but not the O-OBS terminal. The operator will function in momentary contact to close and constant pressure to open.

Following are the monitored devices acceptable for use:

Device	Manufacturer	Description
Prime-Guard	Miller Edge	Monitored Photoeye
Reflecti-Guard	Miller Edge	Retroreflective Monitored Photoeye
IRB-MON	EMX	Monitored Photoeye
IRB-RET	EMX	Retroreflective Monitored Photoeye
The Solution	Miller Edge	Multiple Safety Devices

Any actions taken to circumvent this monitoring are in violation of the UL325, building code, and local laws.

SYSTEM DESIGNER SAFETY INSTRUCTIONS

- ▲ 1. Familiarize yourself with the precautions and warnings for the installer. Users are relying on your design to provide a safe installation. The installation should have an entrapment protection system installed, such as photoelectric sensors or an electric edge.
- ▲ 2. When designing a system that will be entered from a highway or main thoroughfare, be sure the system is placed far enough away from the road to eliminate traffic backup. Distance from the road, size of the gate, usage levels, and gate cycle/speed must be considered to eliminate potential traffic hazards.
- ▲ 3. Design the gate system so a person cannot be trapped between the arm and any other fixed structure. All rigid objects must be at least 2 feet from the gate arm.

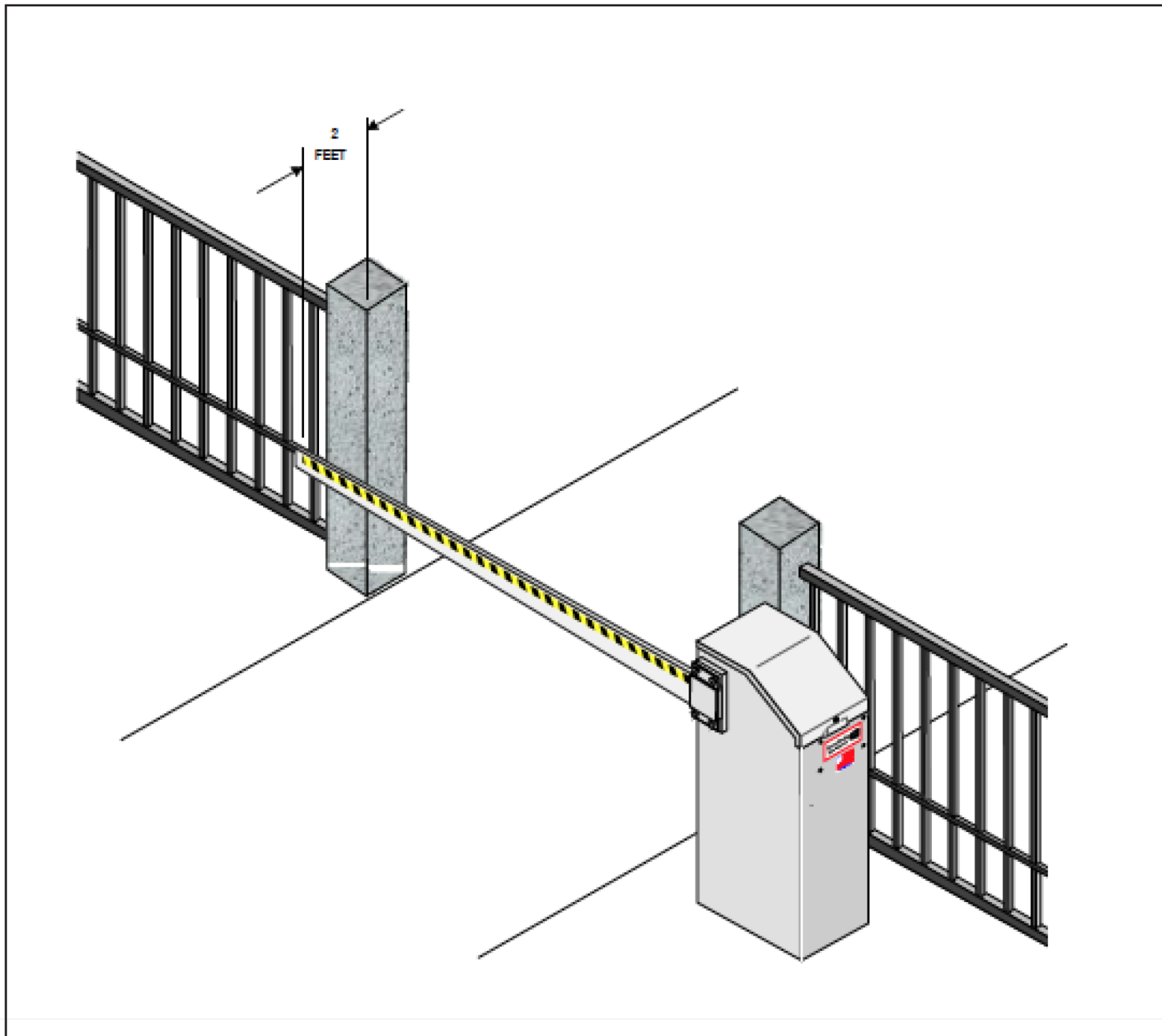

INSTALLER SAFETY INSTRUCTIONS

BEFORE INSTALLATION

- ▲ 1. Check to see that the operator is proper for this type and size of opening and its frequency of use. If you are not sure, consult factory.
- ▲ 2. Check to see that there are no structures adjacent to the area, which may pose a risk of entrapment when gate is opening or closing.
- ▲ 3. Safety equipment such as electric edges or photocell sensors must be installed to provide personnel, equipment, and property protection. For assistance in selecting the correct type of safety equipment, consult the factory.
- ▲ 4. You must install a pushbutton control or key switch to allow for normal operation of the gate if the automatic controls do not work. Locate the push button or key switch and small warning placard within sight of the gate in a secured area at least 10 feet or more from the gate and fence to keep users away from the moving gate and fence.
- ▲ 5. Outdoor or easily accessed gate controls should be of the security type to prohibit unauthorized use.

DURING INSTALLATION

- ▲ 1. Be aware of all moving parts and avoid close proximity to any pinch points.
- ▲ 2. Disconnect power at the control panel before making any electric service connections. Connection location for controls and safety equipment can be found on the wiring diagram, and in control board instructions.
- ▲ 3. Locate the controls at least 10 feet from the moving gate so that the user can observe the gate operation, but is not able to come in contact with the gate while operating the controls.

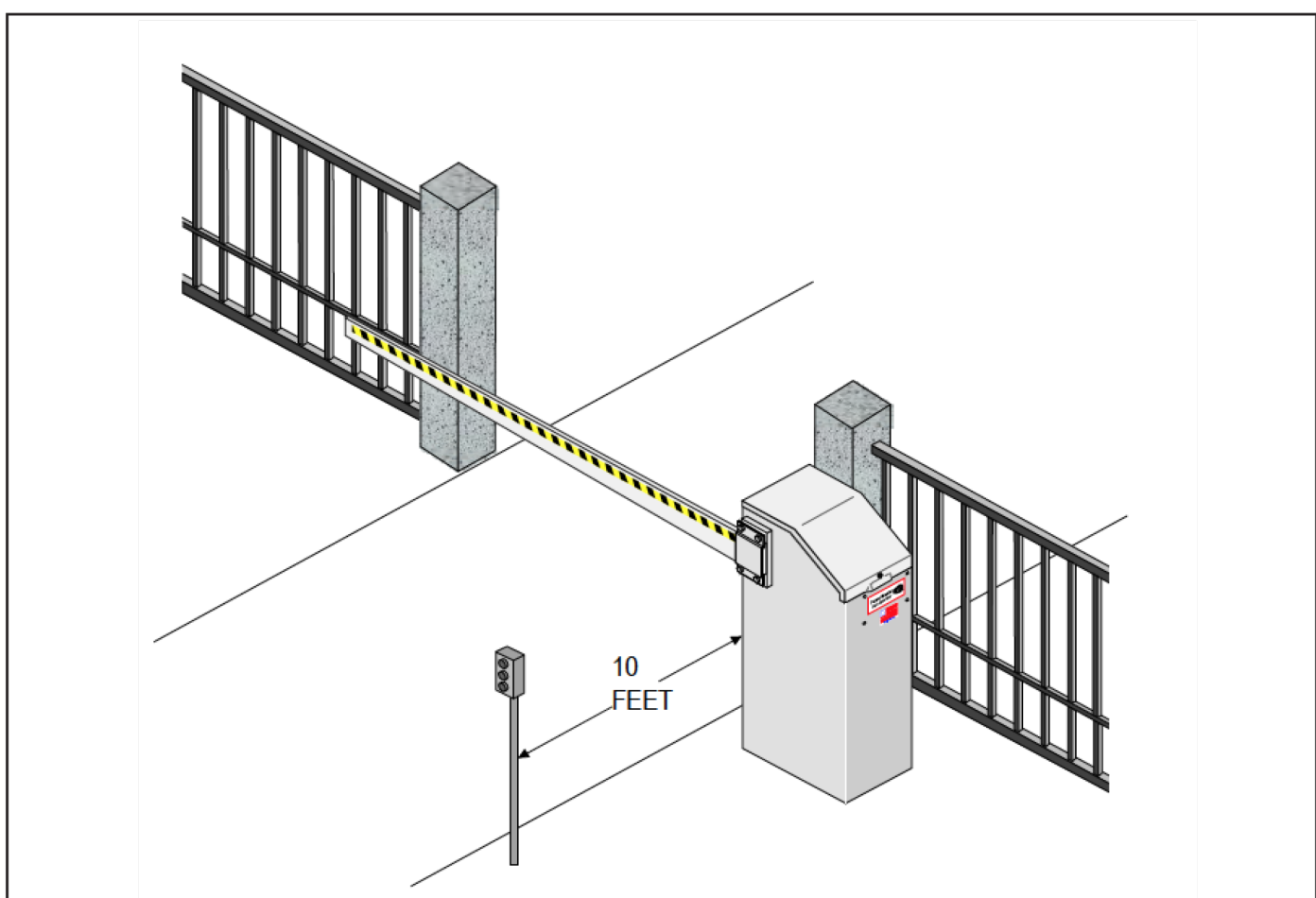

AFTER INSTALLATION

- ▲ You are responsible for ensuring that the end user understands the basic operations and safety systems of the unit, including the proper way to disengage and manually operate this unit.
 - ▲ Point out that the safety instructions in this manual are the responsibility of the end user, and then **LEAVE THIS MANUAL WITH THE END USER.**
-

END USER SAFETY WARNINGS

The manufacturer of the gate operator does not know what type of gate you have, or what type of automatic system is installed on your gate. Be sure you've been fully instructed on the sequence of operation for your specific gate system(s). Keep the gate properly maintained and have a qualified service person make repairs.

- ▲ 1. Be sure the following safety instructions are distributed to all persons authorized to use your gate.



- ▲ 2. **KEEP GATEWAY CLEAR (Front and Back) AT ALL TIMES.** Your automatic gate is not for pedestrian use. No one should ever cross the path of the moving gate.

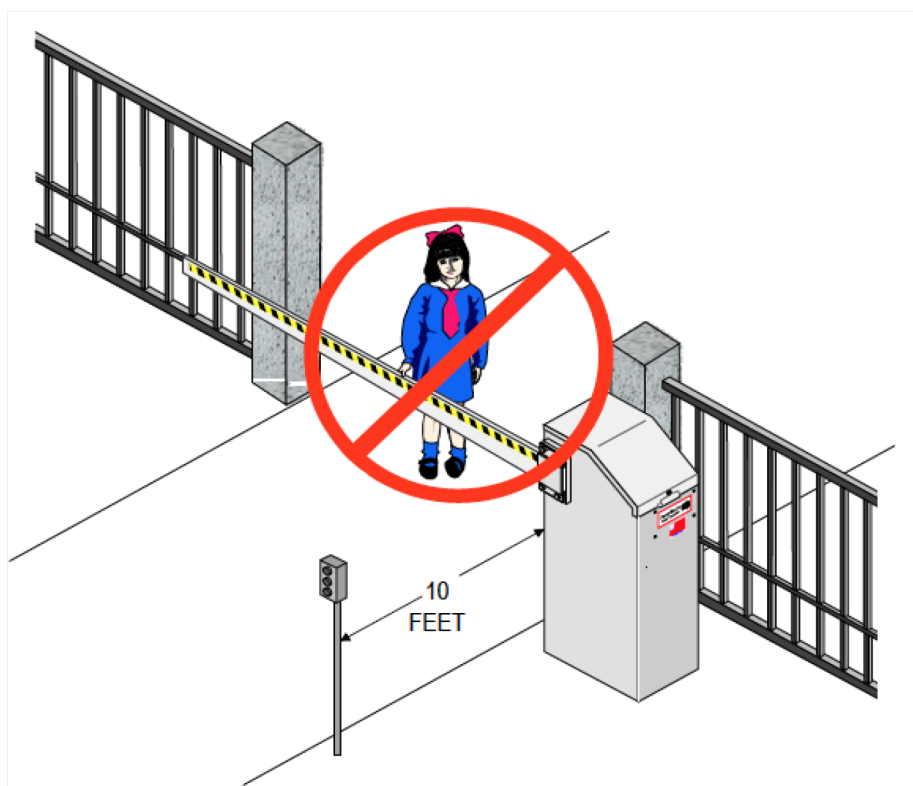

- ▲ 3. DO NOT allow children to play near your gate, or to operate the gate.
 - ▲ 4. DO NOT operate your gate system unless you can see it when the gate moves.
 - ▲ 5. Be sure a pushbutton or key switch has been installed for manual electric operation in the event your radio or card key does not work. Any mounted control station should be located a minimum of 10 feet from the gate so the gate cannot be touched. Any pushbutton located in a building should be installed within sight of the gate.
 - ▲ 6. DO NOT operate any controls without watching the movement of the gate.
 - ▲ 7. Be sure the gate arm DOES NOT come within 2 feet of any rigid object, therefore causing an entrapment situation.
 - ▲ 8. If your gate closes automatically, loop detectors should be installed to detect the presence of a vehicle.
 - ▲ 9. If a contact or non-contact safety system has been installed, check for proper operation at least once per month. **If these functions are observed to operate improperly, discontinue use and have it serviced immediately!**
 - ▲ 10. To ensure safe operation of this equipment, you must read this safety manual and keep it for reference.
-

INSTALLATION INSTRUCTIONS



WARNING

DO NOT APPLY POWER UNTIL TOLD TO DO SO! RISK OF ELECTRICAL SHOCK OR INJURY MAY RESULT!

BEFORE INSTALLING OPERATOR

IMPORTANT:

1. Operator should always be mounted inside the gate.
2. All controls are to be mounted at least 10 feet from the gate arm.
3. Allow at least 2 feet clearance from rigid objects to gate arm.

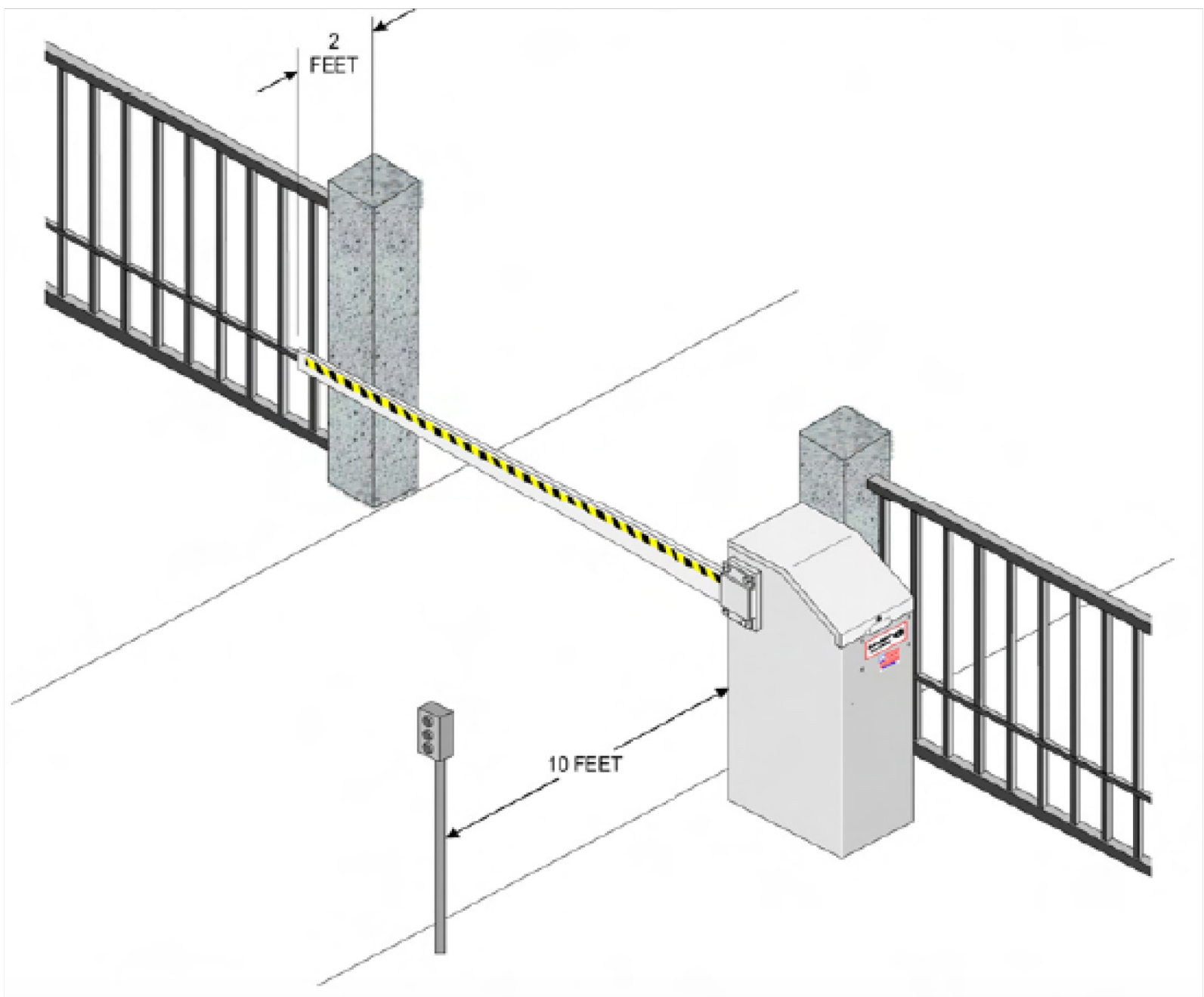

INSTALLATION OF CEMENT PAD

 WARNING	INSTALL OPERATOR MOUNTING PAD SO MOVING ARM WILL ALWAYS BE AT LEAST 2 FEET FROM ANY FIXED OBJECT.
--------------------------------------------------------------------------------------------------	----------------------------------------------------------------------------------------------------------

1. Install a mounting pad as shown below.

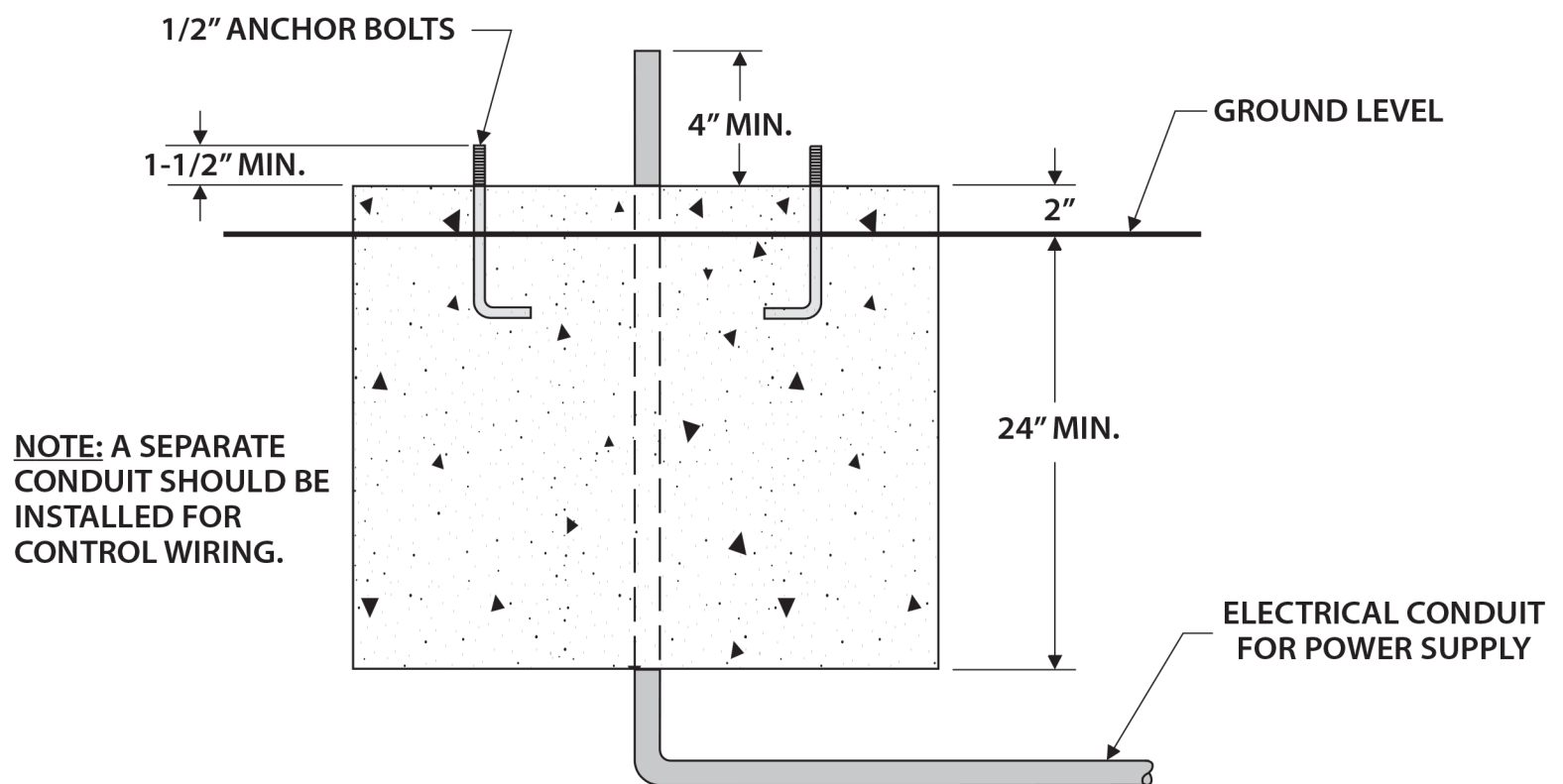
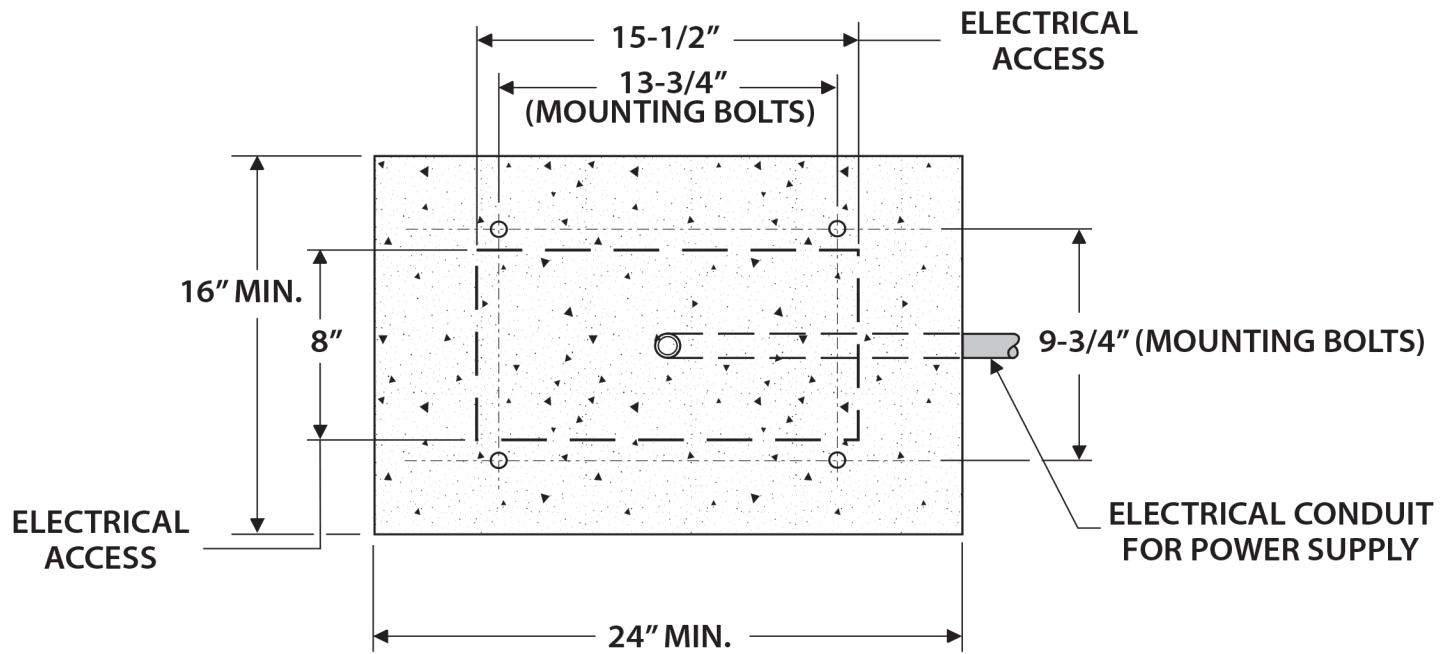

Note: Let cement cure for two days before proceeding.

INSTALLATION OF OPERATOR

1. Remove top cover as follows:
 - Insert key provided and unlock top cover
 - Lift cover from lock side and slide forward
 - Lift off cover
2. Remove side door of operator by reaching inside operator and unscrewing retaining knob at top of door. After removing retaining knob, push out top of door and lift away from operator. See **Figure 1** below.

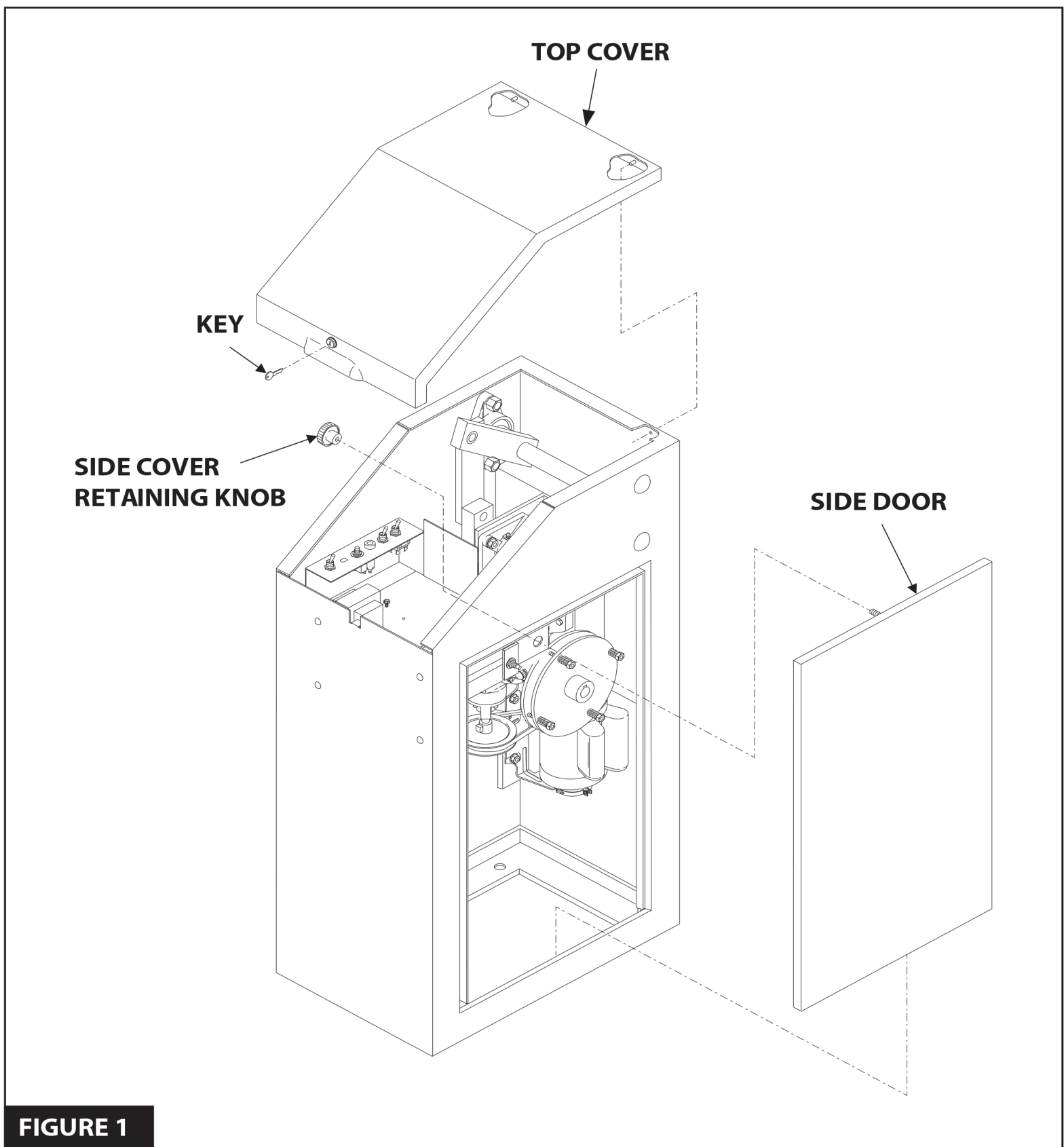

3. Mount operator on pad so that mounting bolts locate in operator base frame mounting holes and operator is parallel to fence line (See **Figure 2** below).
4. Secure operator to cement using 1/2" flat washers, lock washers and hex nuts as shown in **Figure 2**.

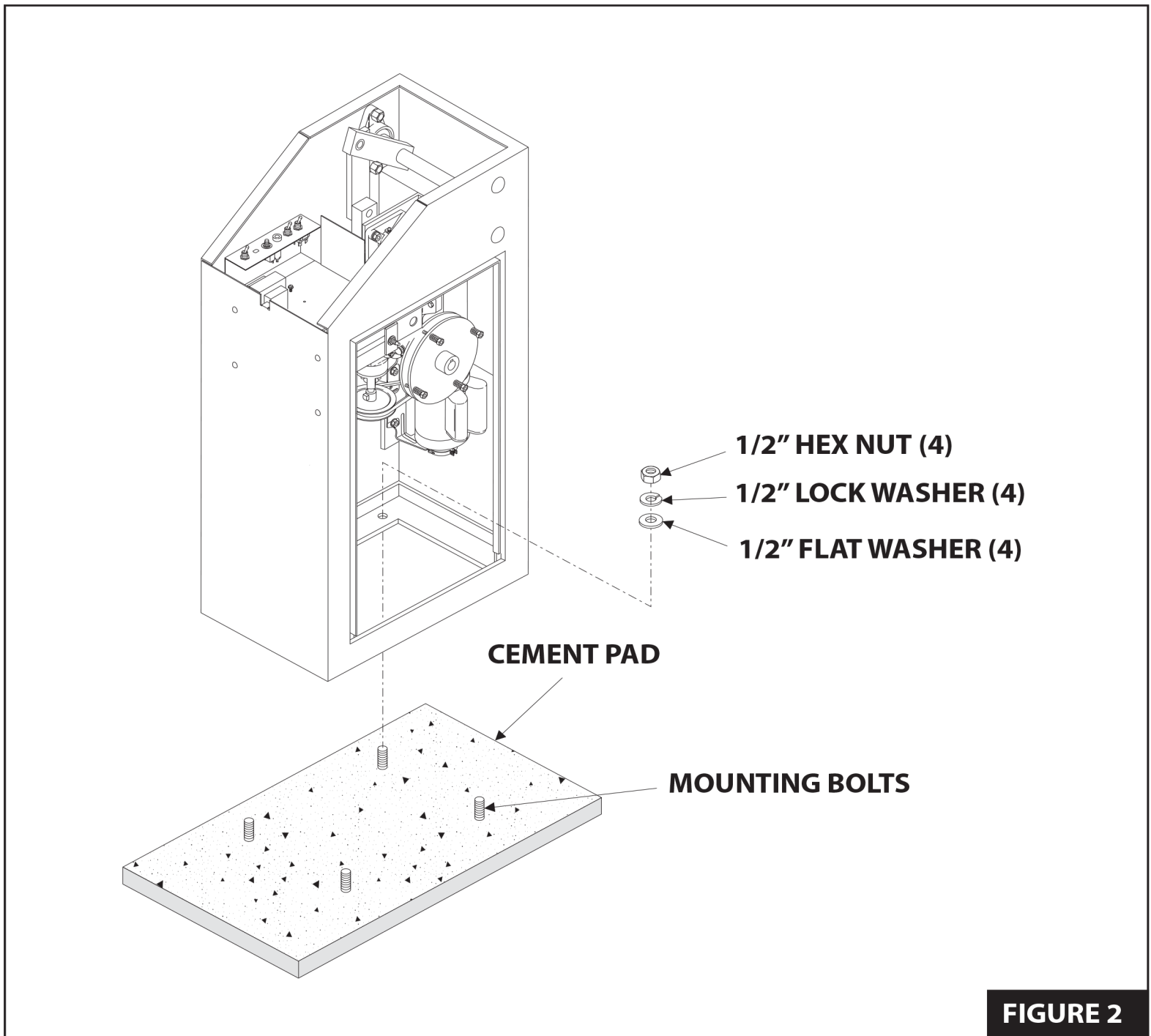

SBG PIPE ARM ASSEMBLY

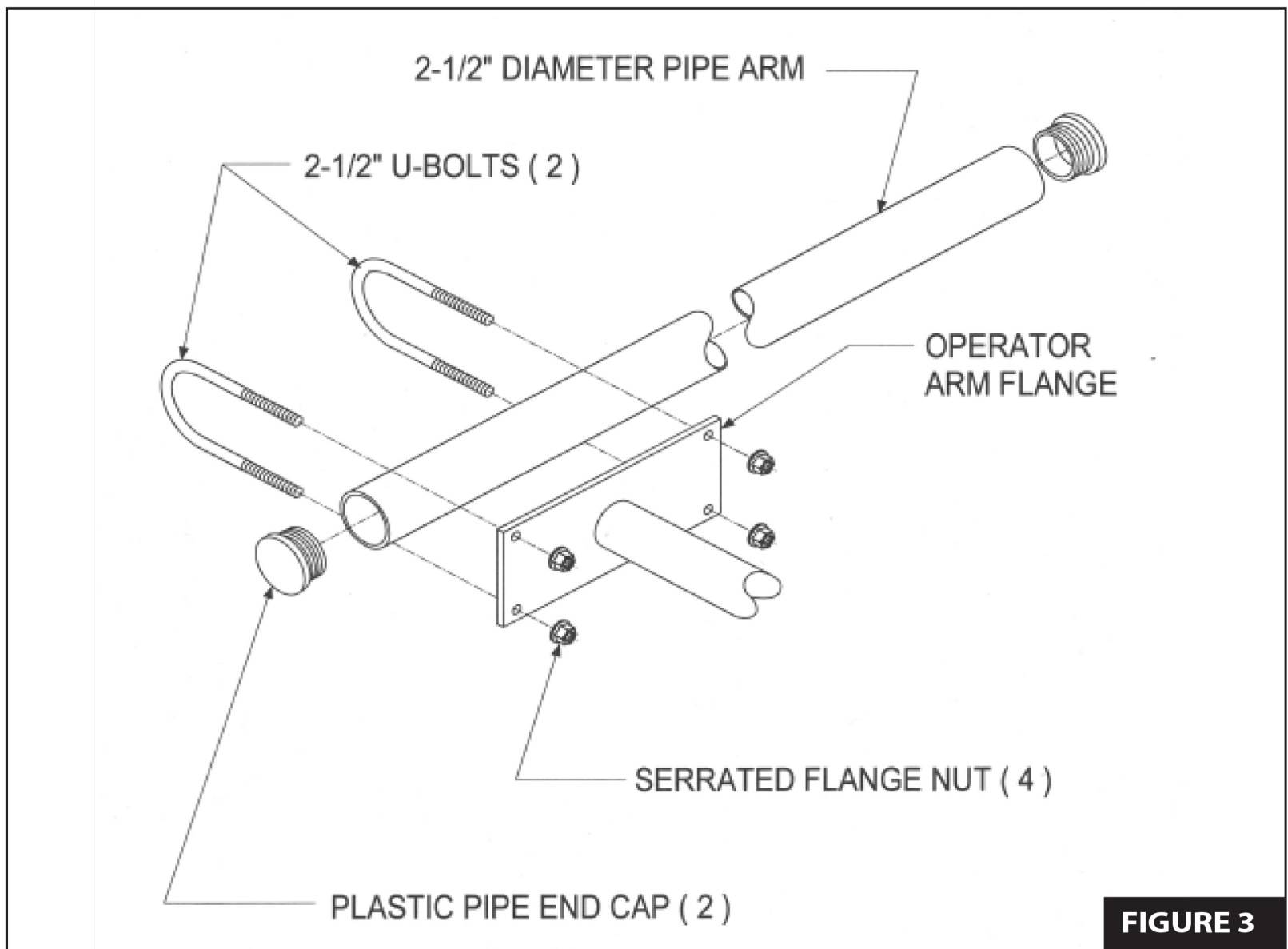

INSTALLATION OF BARRIER ARM

FOR 8', 10', OR 12' DOOR

1. Install arm cap using four (4) 1/2 x 1-1/2" long hex bolts, lock washers and nuts as shown in **Figure 4** below. Do not tighten until told to do so.
2. Insert large end of wood arm into arm cap until flush with opposite edge of arm mounting flange.
3. Adjust arm to the desired horizontal position and secure by tightening the 1/2" mounting hardware.

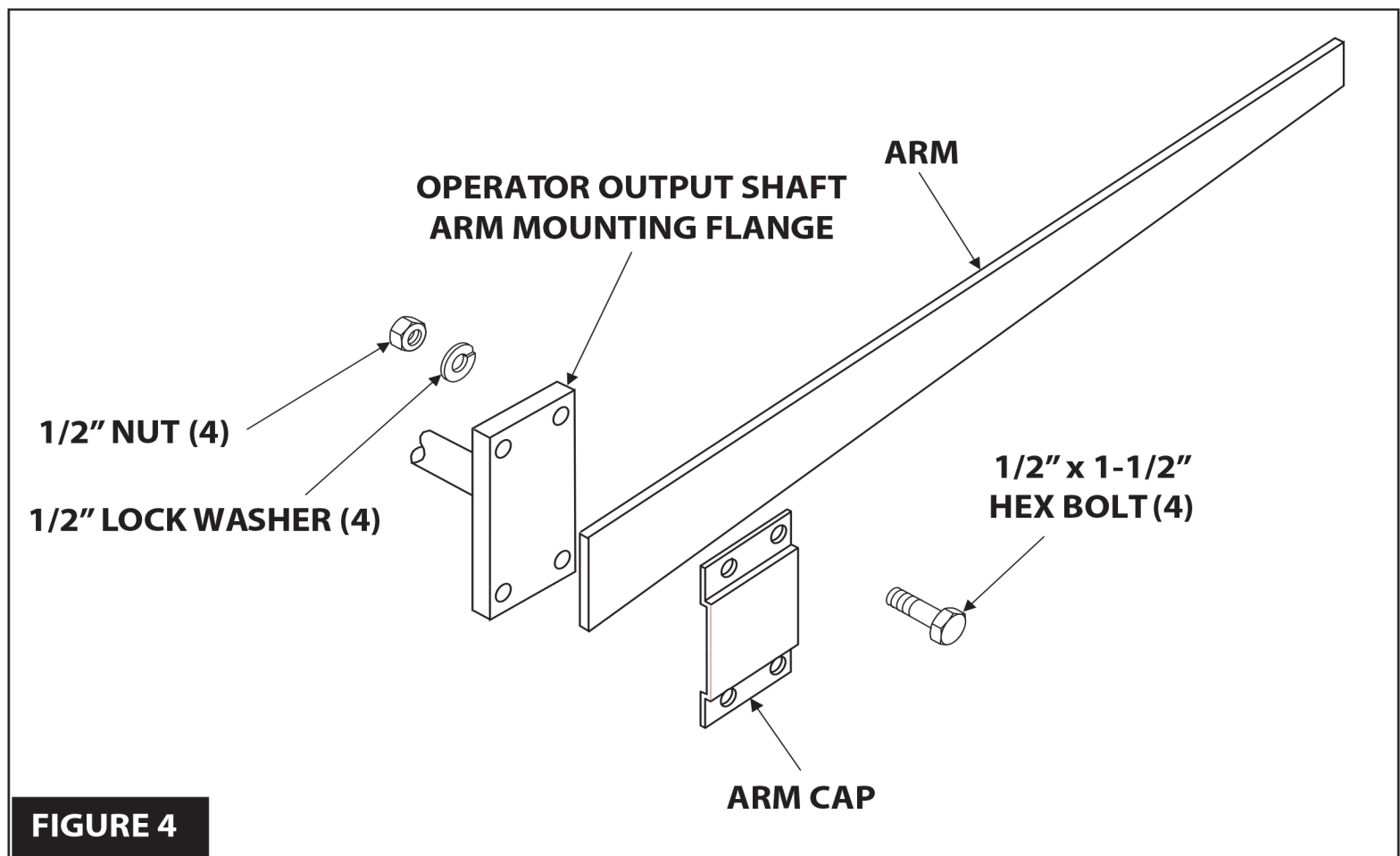

FOR 14' AND 16' DOOR

1. Install weight carrier bracket using four (4) 1/2 x 1-1/2" long hex bolts, lock washers and nuts as shown below. Do not tighten until told to do so.
2. Insert large end of wood arm into weight carrier bracket until it hits Stop.
3. Adjust the arm to the desired horizontal position and secure by tightening the 1/2" mounting hardware.
4. Mount counter weight on weight carrier bracket using two (2) 1/2" x 4" long hex bolts, lock washers and nuts. Be sure to use holes in weight carrier bracket as shown in **Figure 5** for proper arm balance.

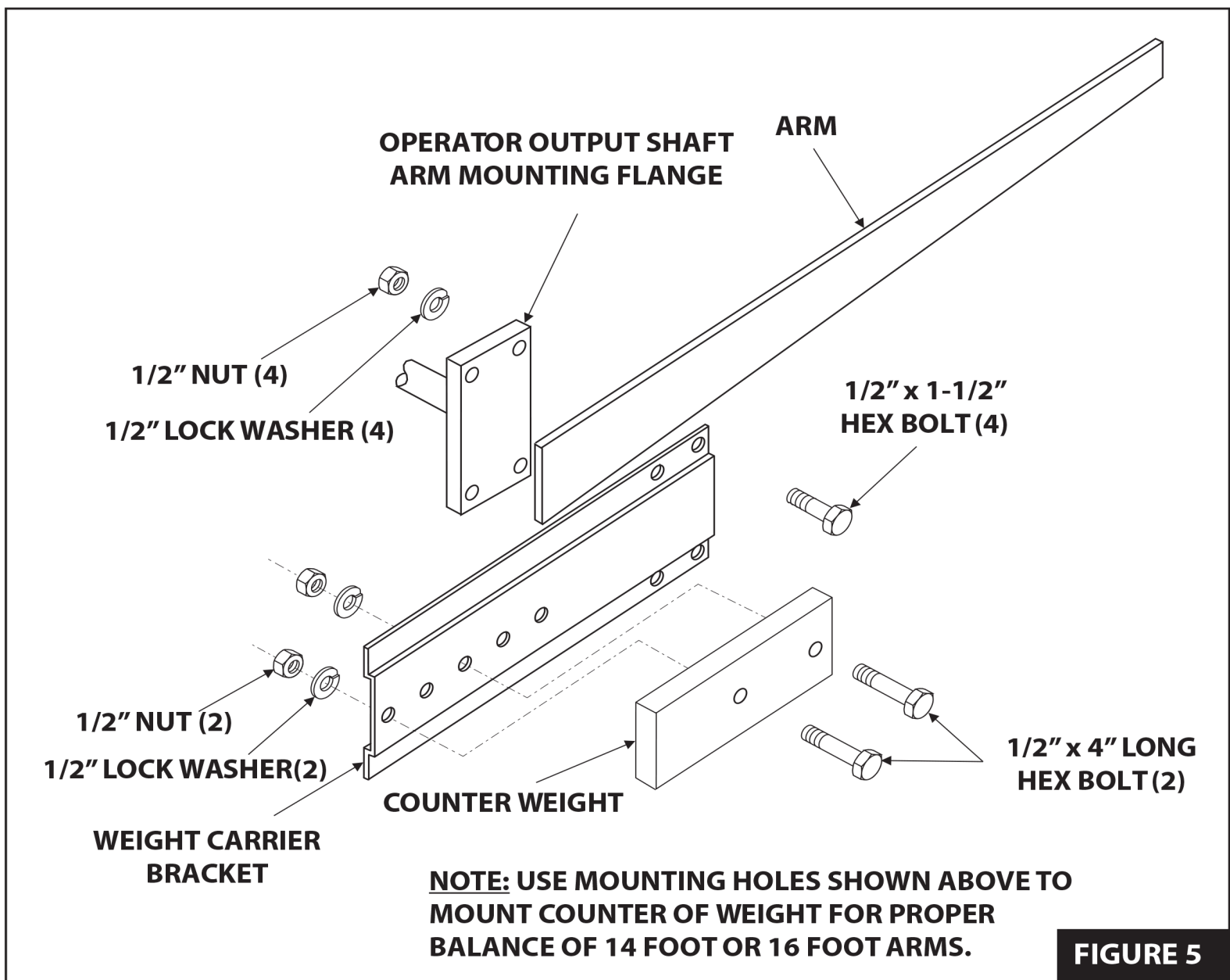

ELECTRICAL CONNECTIONS

 WARNING	DO NOT APPLY POWER UNTIL TOLD TO DO SO! RISK OF ELECTRICAL SHOCK OR INJURY MAY RESULT!
--------------------------------------------------------------------------------------------------	-----------------------------------------------------------------------------------------------

NOTE: Before connecting the operator, use a voltmeter to determine that the electrical service is 115V. **THIS OPERATOR CANNOT BE CONNECTED AT 230 VOLTS.** Damage will result which is not covered under warranty.

NOTE: Wiring to operator must use watertight materials in accordance with local electric code. See the following wire gauge/distance charts for proper sizing. Master/Slave installations should have SEPARATE power supply wiring or length of wire runs should be figured at half that shown on the chart. **This unit must be grounded in accordance with N.E.C. and local codes.**

LINE VOLTAGE	HP	WIRE GAUGE				
		14 AWG	12 AWG	10 AWG	8 AWG	6 AWG
115VAC	1/2	150'	250'	400'	500'	650'

LOW VOLTAGE WIRE GAUGE/ DISTANCE CHART
24 AWG: UP TO 150'
20 AWG: 150' - 200'
18 AWG: 250' - 1,500'
Control wiring should be run as twisted pairs. DO NOT run control wires in the same conduit as power wires, telephone wires, or loop detector leads.

1. Be sure the power switches at source, and at the operator are **OFF**.
2. Connect incoming power lines and ground wire as shown below.

Hot leg (Black) to Black; Neutral (white) to White; Ground to Green

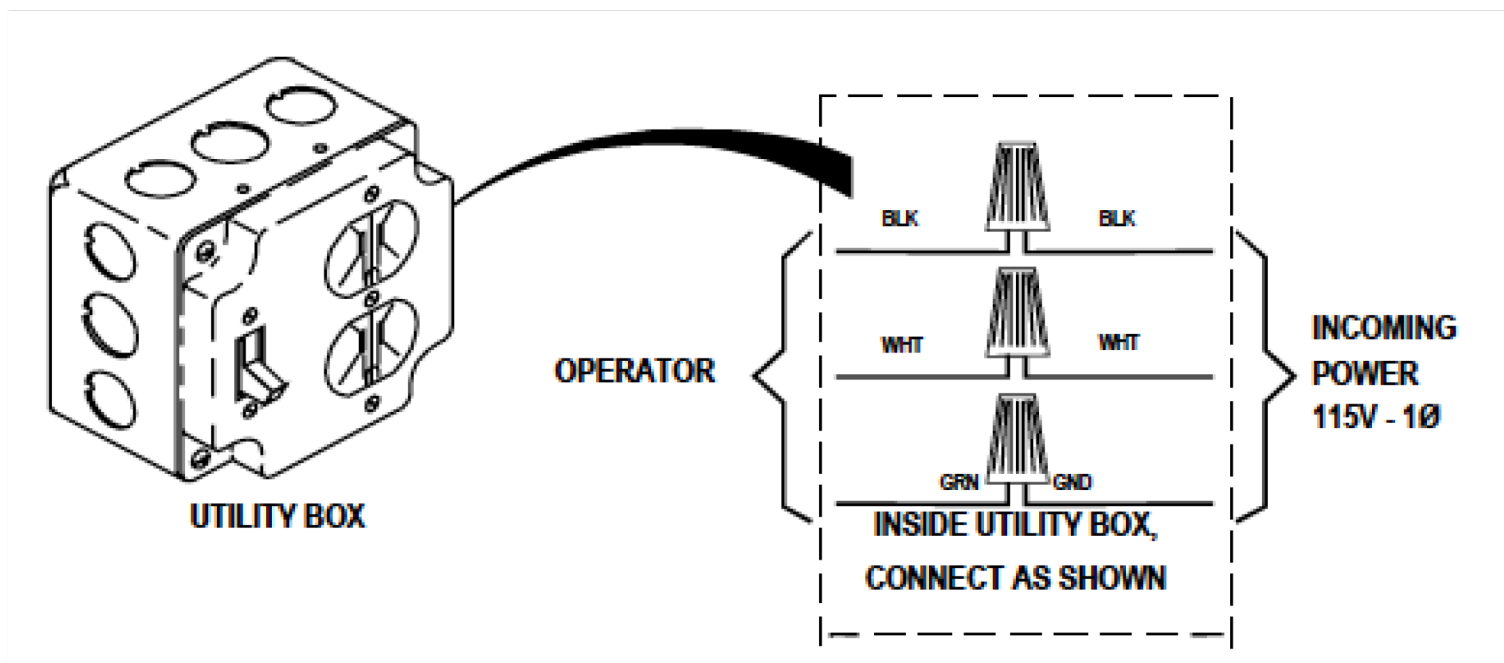

MANUAL OPERATION

1. Remove top cover and side door.
2. Use manual crank on reducer pulley to open gate.



WARNING

TO AVOID INJURY, TURN OFF POWER SUPPLY SWITCH TO OPERATOR BEFORE MAKING ANY ADJUSTMENTS.

LIMIT ADJUSTMENT PROCEDURE



WARNING

TURN OFF POWER SUPPLY BEFORE MAKING ANY ADJUSTMENTS

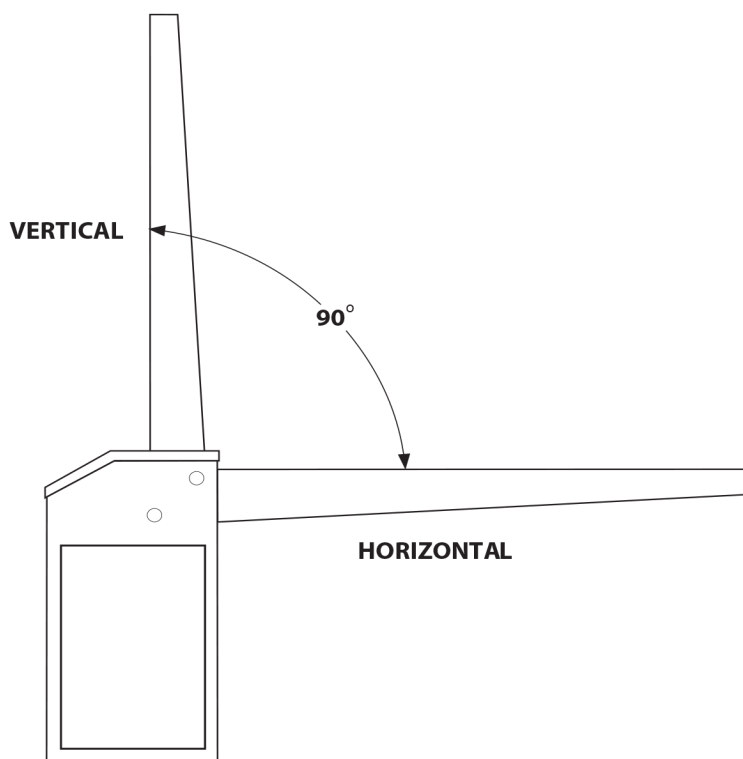

NOTE: The drive linkage geometry prevents more than a 90 degree gate arm movement (Horizontal to Vertical position).

1. In order to achieve 90 degree arm movement from the drive linkage, the limit cams must be set to obtain the linkage positions shown in **Figure 6** below.

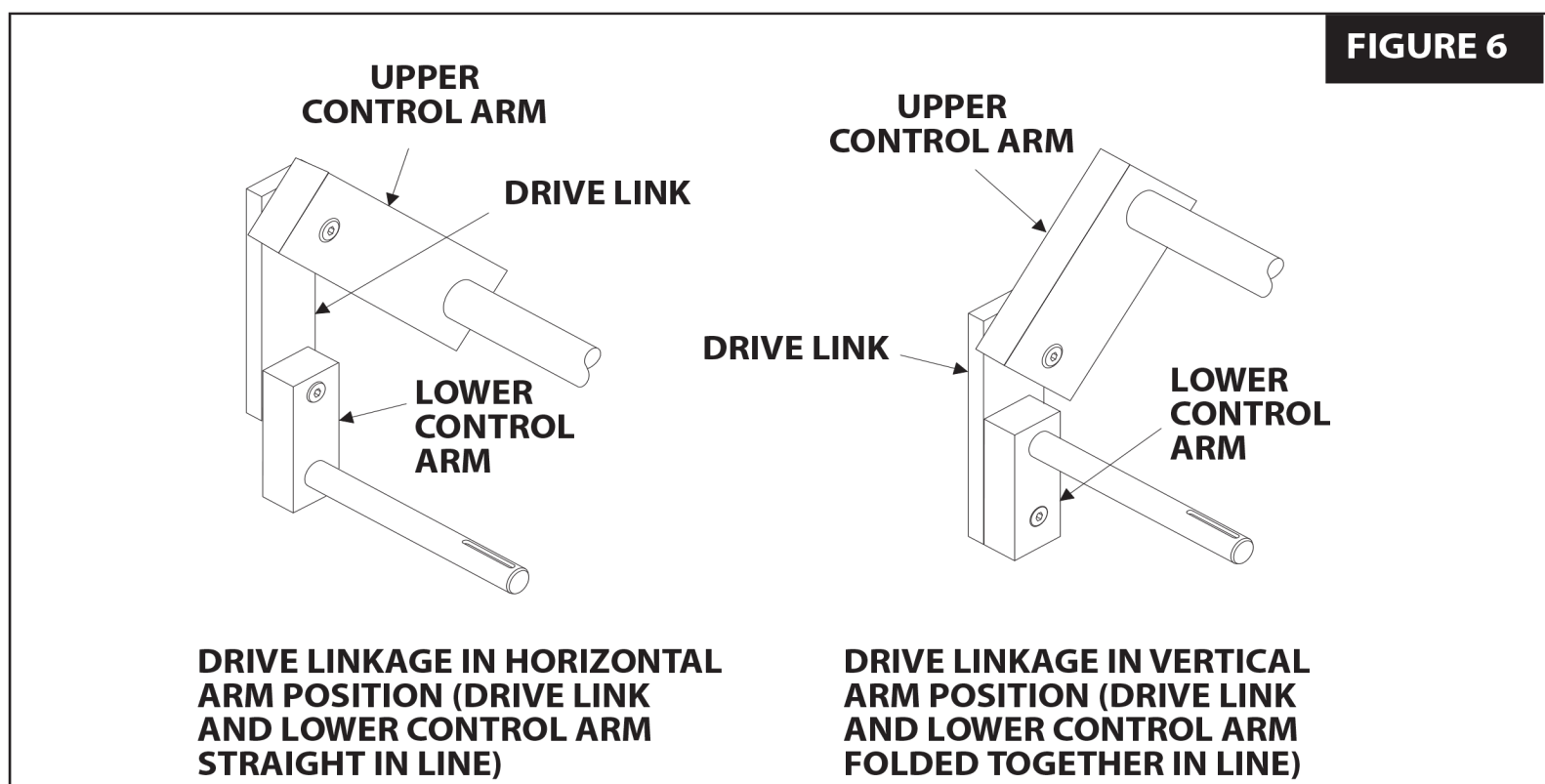

2. To set limit cam, loosen set screw and rotate to desired position then tighten set screw.

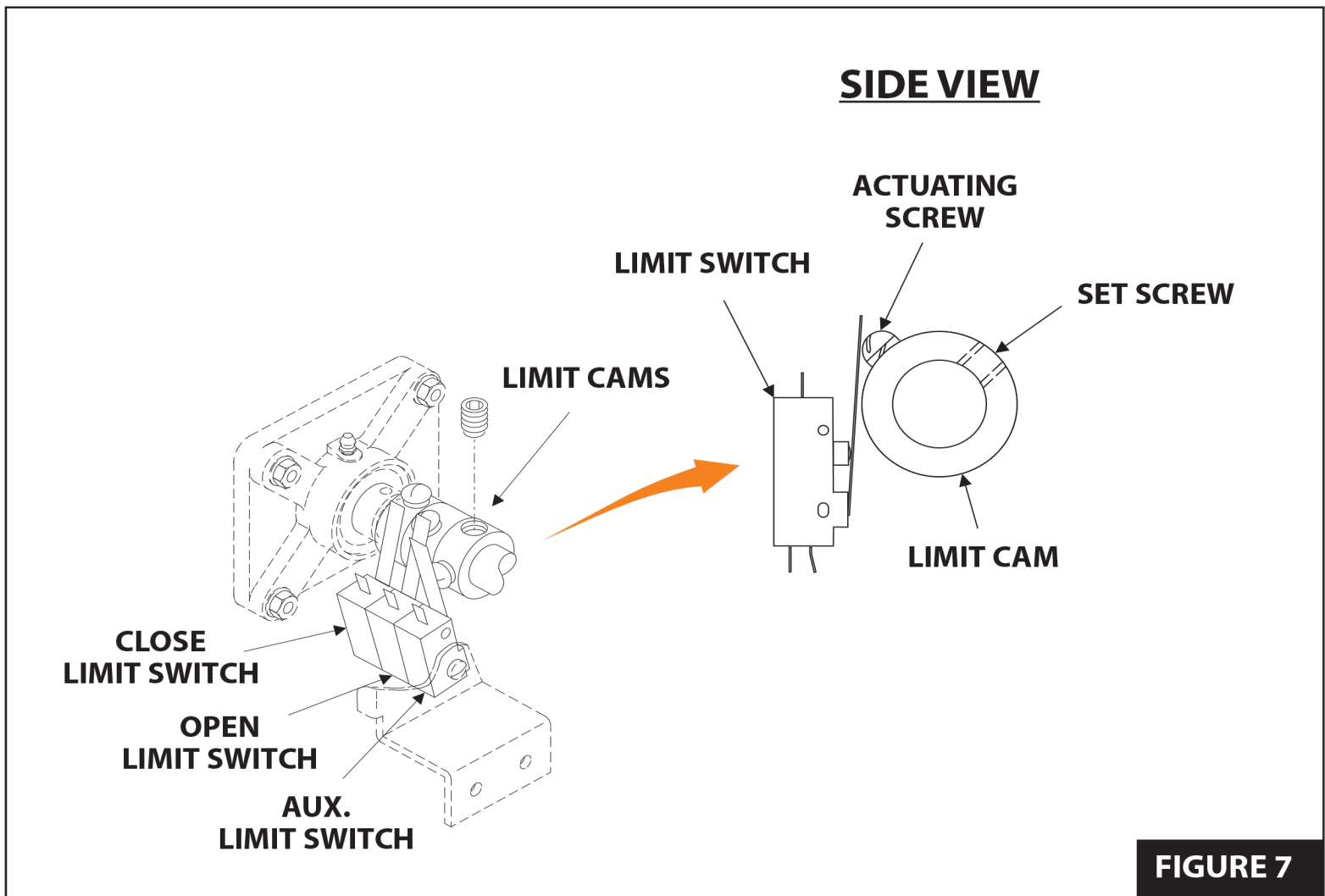

Note: Limits are set for 90 degree arm movement at factory.

3. If a shorter stroke than 90 degrees is desired at either end, limits may be reset to achieve this.
4. If the limit cams are adjusted correctly and the operator is maintaining 90 degree rotation but the arm is not horizontal in the down position; loosen the (4) mounting bolts, adjust arm and retighten mounting bolts.

INSTALLATION OF EDGE SENSOR OR PHOTO EYES

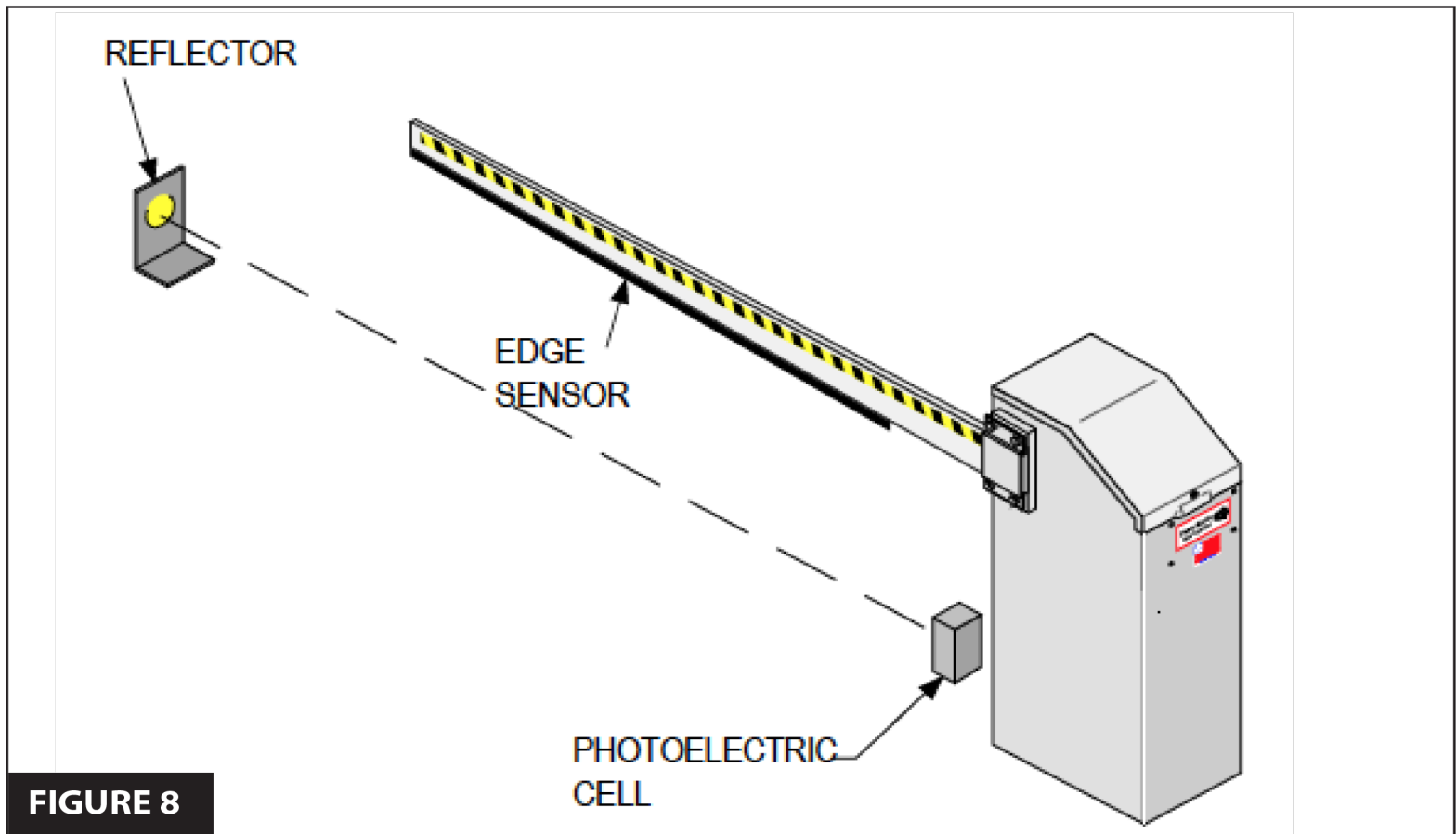

FIGURE 8

NOTE: 24 VAC power is available for devices such as photo eyes, wireless edges, etc. All safety device contacts must be NORMALLY OPEN.

1. Install edge sensor or photoelectric eye system as shown in Figure 8. Photocells should be installed at least 10" above the ground.

NOTE: All hard wiring to safety edge must be installed so there is no threat of mechanical damage to wiring between components, when the gate is moving.

NOTE: A separate pedestrian gate must be installed if there is no other entry access but the vehicular gate.

AUXILIARY LIMIT SWITCH

There is an auxiliary limit switch available which provides a normally open and normally closed set of contacts for use with additional equipment. Adjustment is accomplished by rotating the auxiliary. Limit cam to the desired position and securing that location with the set screw in the cam.

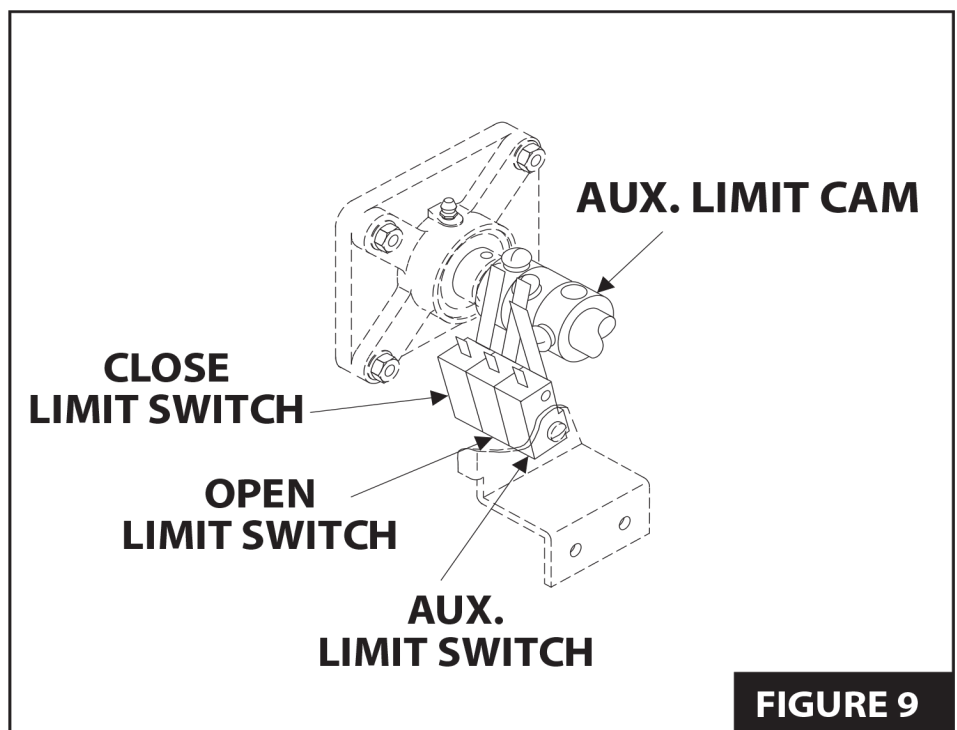
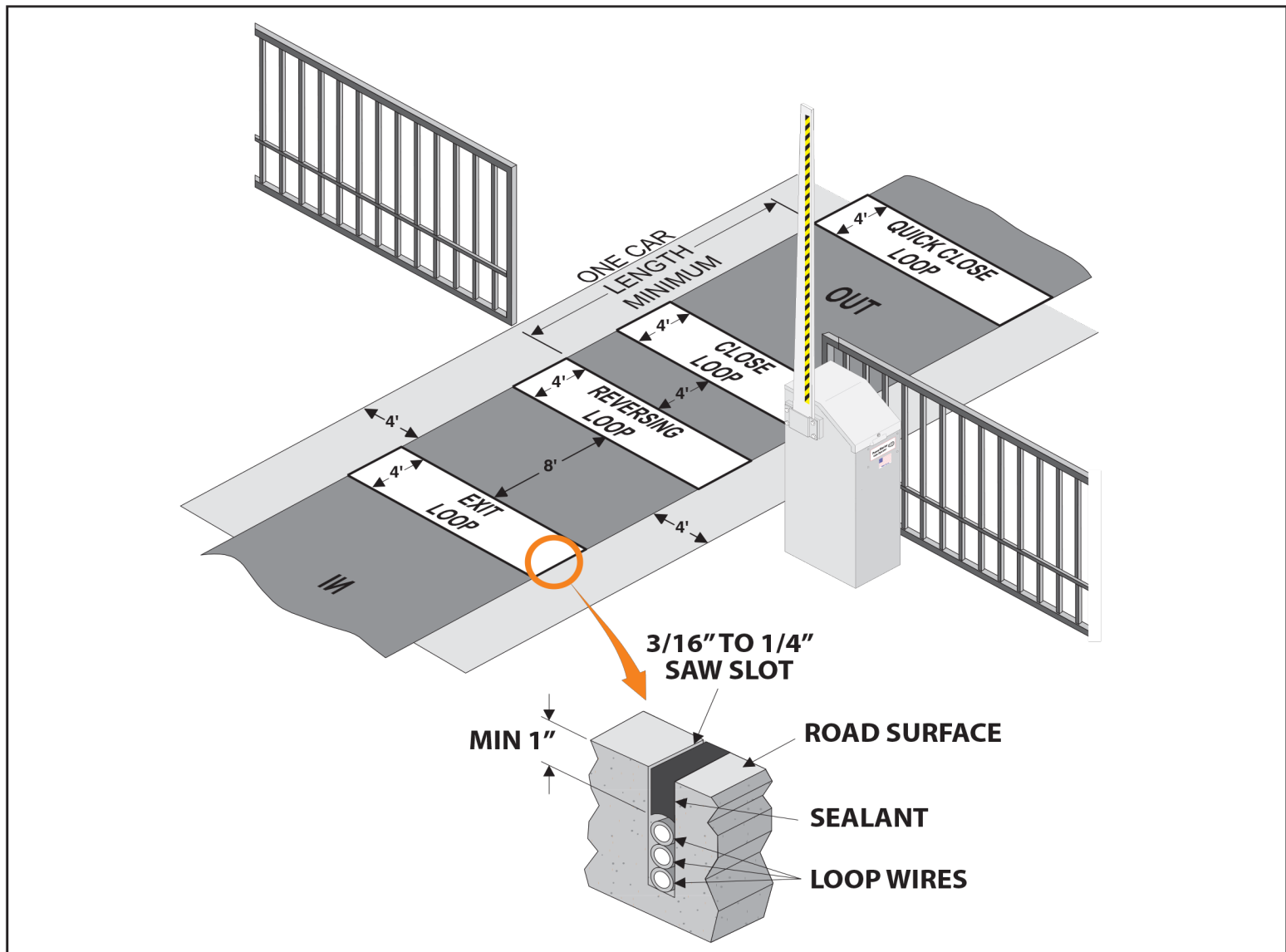

FIGURE 9

LOOP DETECTOR SYSTEMS AND INSTALLATION



1. The **Exit Loop** provides a signal to open the gate when a vehicle enters the loop zone.
2. The **Reversing Loop** protects a vehicle in the loop zone from being contacted by the gate by overriding any close signal while the gate is open, and by reversing the gate if closing UNLESS the Quick Close Anti Tailgate loop has been installed.
3. The **Quick Close Loop** (Anti Tailgate feature) is usually used for one-way traffic. Once activated, it will disable any CLOSE SAFETY devices and can only be overridden by an **OPEN** input. Therefore, this option should ONLY be used in secure applications and a CLOSE WARNING device should be connected.

LOOP INSTALLATION

1. Lay out the desired loop locations per the diagram. The standard size chart on the following page will give an approximate length of wire required for various loop dimensions and number of turns required.

NOTE: Length of lead-in wires must be added to loop lengths for total length of wire required.

CAUTION: The loop wires and lead-in wires must be a continuous piece of wire without splices. Only use wire intended for this type of application (Type XHHW insulation 16AWG).

NOTE: Buried steel from drains or other systems may affect functioning of the loop system. Check with the factory for advice on any special installations. Call 1-800-243-4476.

STANDARD LOOP LAYOUTS FOR APPROX. 36" HEIGHT DETECTION

LOOP SIZE	# OF TURNS	LOOP WIRE LENGTH
4' X 4'	4	64'
4' X 6'	4	80'
4' X 8'	3	72'
4' X 10'	3	84'
4' X 12'	3	96'
4' X 14'	3	108'
4' X 16'	3	120'
4' X 18'	3	132'
4' X 20'	3	144'
4' X 22'	3	156'
4' X 24'	3	168'
4' X 26'	3	180'
4' X 28'	3	192'
4' X 30'	2	136'
4' X 32'	2	144'
4' X 34'	2	152'
4' X 36'	2	160'
4' X 38'	2	168'
4' X 40'	2	176'

- Cut the required groove at the locations laid out in **Step#1** according to the diagram below (**Figure 10**).

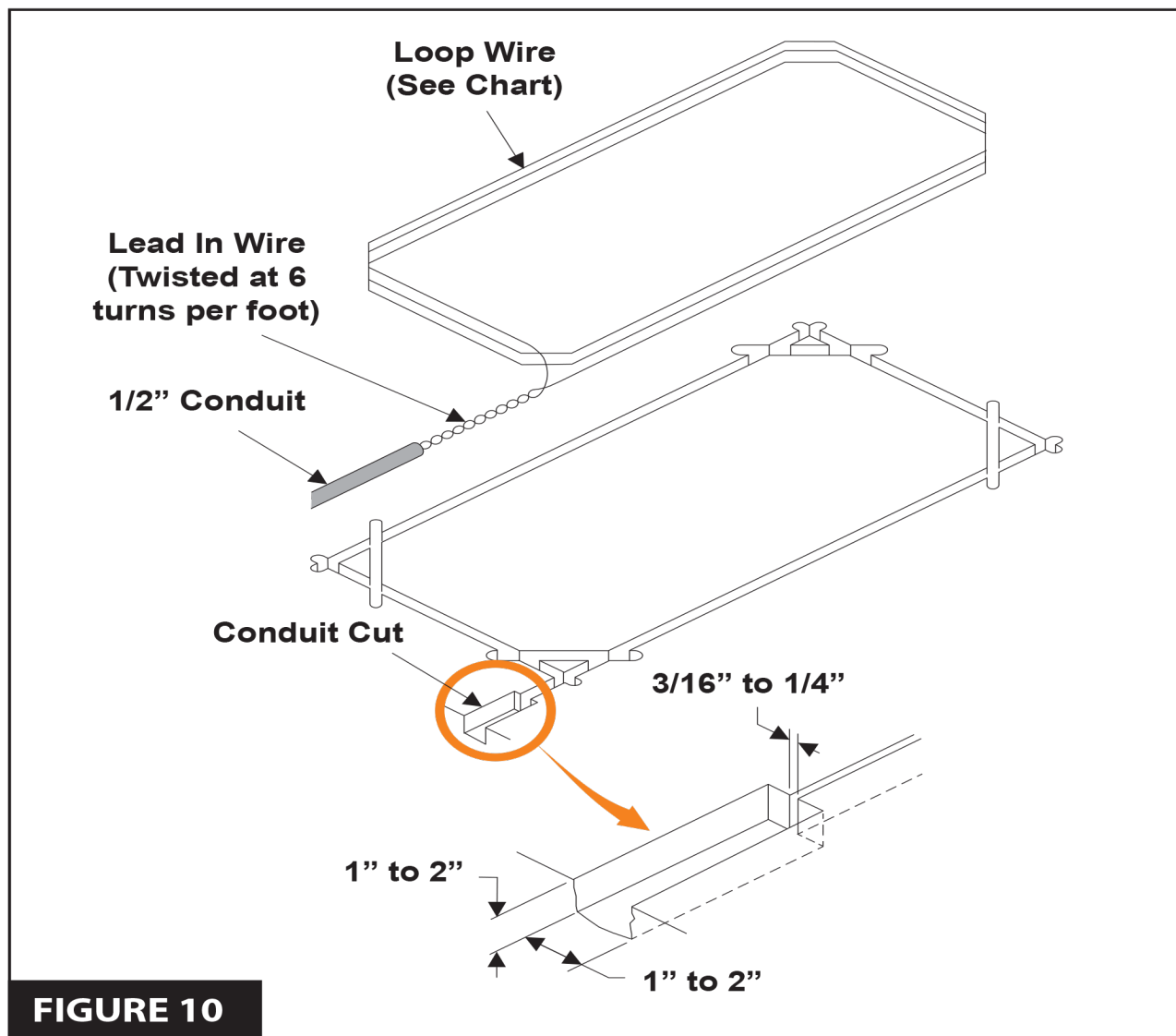

3. Leaving enough wire for the lead-in, insert the specified number of turns of wire in the cut grooves (See chart).

CAUTION: Be careful not to damage the wire insulation during installation.

4. After completing the required number of loop turns, twist the ends together at the rate of 6 turns per foot to form the lead-in.
 5. Seal the lead-in wire in the conduit to prevent moisture seepage into the conduit.
 6. Fill over the loop wires in the groove with a recommended loop sealant. Contact your distributor for available sealants.
-





























powermaster

SUPPLEMENTARY INSTRUCTIONS FOR UNITS EQUIPPED WITH THE **PowerMaster Controller**



Indicator Descriptions

INDICATOR DEFINITION		INDICATION WHEN LIT DURING NORMAL OPERATION	INDICATION WHEN LIT DURING PROGRAMMING
OPERATION	PROGRAMMING		
24 VOLT INPUT POWER		LOW VOLTAGE AC POWER IS PRESENT	
24 VOLT DC ACCY POWER		LOW VOLTAGE DC POWER IS PRESENT	
OPEN		OPEN SIGNAL PRESENT FROM THE INTERNAL RECEIVER OR AN EXTERNAL DEVICE CONNECTED TO THE OPEN INPUT TERMINAL	
CLOSE		CLOSE SIGNAL IS PRESENT FROM A DEVICE CONNECTED TO THE CLOSE INPUT TERMINAL	
STOP		STOP INPUT TERMINAL IS OPEN AND NOT CONNECTED TO COMMON	
PROGRAM			CONTROLLER IS IN PROGRAMMING MODE
REVERSE	DELAY SET	SIGNAL FROM REVERSING DEVICE IS PRESENT	SET REVERSE DELAY TIME
LOCKOUT	ALARM SET	CONTROLS AND OPERATOR ARE LOCKED OUT BECAUSE OF EXISTING TROUBLE CONDITION	SET RUN ALARM AND PRE-START ALARM
RADIO	LEARN	BUILT-IN RECEIVER IS DETECTING A RADIO SIGNAL FROM A REMOTE CONTROL	TRANSMITTERS CAN BE ENTERED INTO MEMORY (UP TO 40 TRANSMITTERS)
OPEN CURRENT	SET	MOTOR CURRENT HAS EXCEEDED THE OPEN CURRENT SETTING WHILE OPENING	SET MAXIMUM OPEN CURRENT
OPEN OBSTR	MGT 2 SET	OPEN OBSTRUCTION TERMINAL CONNECTED TO COMMON BY BEAM OR SAFETY EDGE, OR SIGNAL FROM MGT OBSTACLE TRANSMITTER	SET MGT #2 FUNCTION
OPEN RELAY	LH/RH SET	OPEN RELAY IS ACTIVATED	SET LEFT-HAND RIGHT-HAND OPERATION
OPEN LIMIT	BRAKE DELAY	OPEN LIMIT SWITCH IS ACTIVATED	
CLOSE CURRENT	SET	MOTOR CURRENT HAS EXCEEDED THE CLOSE CURRENT SETTING WHILE CLOSING	SET MAXIMUM CLOSE CURRENT
CLOSE OBSTR	MGT 1 SET	CLOSE OBSTRUCTION TERMINAL CONNECTED TO COMMON BY BEAM OR SAFETY EDGE, OR SIGNAL FROM MGT OBSTACLE TRANSMITTER	SET MGT #1 FUNCTION
CLOSE RELAY	AUTO CLOSE SET	CLOSE RELAY IS ACTIVATED	SET AUTO-CLOSE TIME
CLOSE LIMIT	AC DC SET	CLOSE LIMIT SWITCH IS ACTIVATED	SET MOTOR TYPE
SINGLE	SET	SINGLE TERMINAL CONNECTED TO COMMON BY AN EXTERNAL PUSHBUTTON OR RADIO	SET SINGLE BUTTON INPUT FUNCTION
MAX RUN	SET	MAXIMUM RUN TIMER HAS BEEN EXCEEDED	SET MAXIMUM RUN TIME
COMM LINK	SET	DUAL OPERATOR CONNECTION DETECTED, BLINKS IF CONNECTION HAS FAILED	
MAINT ALERT	SET	MAINTENANCE IS REQUIRED ON OPERATOR	SET MAINTENANCE ALERT CYCLE COUNT

powermaster Controller Function Display Indications			
 "RL" LEFT OR RIGHT HAND OPERATION	 "SB" SINGLE BUTTON INPUT SETUP	 "LP" LOW POWER MODE	 "MO" MOTOR TYPE SELECTION
 "PM" SINGLE OR DUAL GATE	 "SM" STAGGER MODE	 "FS" POWER FAILURE MODE	 "RA" RADIO ENABLE
 "AC" AUTO CLOSE TIMER	 "ST" STAGGER TIME	 "SS" SOFT START/STOP DURATION	 "TL" LEARN TRANSMITTERS
 "RP" RUN ALARM PRE-START ALARM	 "AR" AUXILIARY RELAY MODE	 "CT" RESET CYCLE COUNT	 "TD" DELETE TRANSMITTERS
 "OC" MAXIMUM OPEN CURRENT	 "RD" REVERSE DELAY TIME	 "MA" MAINTENANCE ALERT TRIGGER	 "ML" LEARN MGT TRANSMITTERS
 "CC" MAXIMUM CLOSE CURRENT	 "CP" CONSTANT PRESSURE MODE	 "MT" MID-TRAVEL STOP POSITION	 "MD" ERASE MGT TRANSMITTERS
 "AD" ADVANCED PROGRAMMING	 "SP" SHADOW LOOP OPEN INHIBIT	 "AT" ANTI-TAILGATE ENABLE	 "CL" RESET TO FACTORY DEFAULTS
 "RT" MAXIMUM RUN TIMER			

Terminal Descriptions



TERMINAL	GROUP	FUNCTION
AC N AC	24 VOLT INPUT	FACTORY CONNECTED TO 24 VAC FROM TRANSFORMER OR 24 VDC FROM CONTINUOUS DUTY DC SUPPLY.
DC - DC +	ACCESSORY POWER	PROVIDES 24 VOLT DC POWER FOR ACCESSORIES. (.5A MAX)
RESET COMMON	RESET BUTTON	FACTORY CONNECTED TO THE CONTROLLER'S RESET BUTTON.
C B A	COMM LINK	FOR 3-WIRE NETWORK CONNECTION TO SECOND OPERATOR IN DUAL GATE INSTALLATIONS.
COMMON SINGLE	SINGLE BUTTON INPUT	CONNECT TO NORMALLY OPEN SWITCH FOR SINGLE BUTTON OPERATION. ALTERNATES BETWEEN OPEN-CLOSE OR OPEN-STOP-CLOSE DEPENDING ON PROGRAMMING.
COMMON FIRE DEPT	FIRE BOX INPUT	CONNECT TO NORMALLY OPEN SWITCH IN FIRE BOX FOR FIRE DEPARTMENT ACCESS.
COMMON OPEN	OPEN INPUT	CONNECT TO NORMALLY OPEN DEVICES (KEYPAD, CARD READER, KEYSWITCH, TELEPHONE ENTRY SYSTEM) TO OPEN THE GATE. A CONSTANT OPEN INPUT WILL OVERRIDE THE MID-TRAVEL STOP AND HALT THE AUTO CLOSE TIMER UNTIL RELEASED.
OPEN CLOSE COMMON STOP	3-BUTTON STATION INPUT	CONNECT TO 3-BUTTON STATION FOR OPEN-CLOSE-STOP CONTROL. A CONSTANT OPEN INPUT WILL OVERRIDE THE MID-TRAVEL STOP AND HALT THE AUTO CLOSE TIMER UNTIL RELEASED.
COM O-OBS	OPEN OBSTRUCTION INPUT	CONNECT TO NORMALLY OPEN DEVICES (GATE EDGE, PHOTO BEAM) TO DETECT AN OBSTRUCTION DURING OPENING. WHILE GATE IS MOVING, ANY OPEN OBSTRUCTION SIGNAL WILL CAUSE THE GATE TO STOP, REVERSE A SHORT DISTANCE, AND THEN STOP AGAIN. AT THIS TIME THE AUTO CLOSE TIMER IS DISABLED, AND A RENEWED INPUT WILL BE REQUIRED TO START THE GATE AGAIN. SHOULD THE GATE BE RESTARTED AND THE OBSTACLE SIGNAL OCCUR AGAIN PRIOR TO REACHING A LIMIT, THE GATE WILL STOP AGAIN, LOCKOUT, AND SOUND THE CONTINUOUS TONE ALARM.
C-OBS COM	CLOSE OBSTRUCTION INPUT	CONNECT TO NORMALLY OPEN DEVICES (GATE EDGE, PHOTO BEAM) TO DETECT AN OBSTRUCTION DURING CLOSING. WHILE GATE IS MOVING, ANY CLOSE OBSTRUCTION SIGNAL WILL CAUSE THE GATE TO STOP, THEN REVERSE AND TRAVEL TO THE FULL OPEN POSITION. SHOULD A OPEN OBSTRUCTION INPUT OR AN OPEN DIRECTION INHERENT ENTRAPMENT CONDITION OCCUR PRIOR TO THE GATE REACHING THE OPEN LIMIT, THE OPERATOR WILL LOCKOUT AND SOUND THE CONTINUOUS TONE ALARM. IF THE AUTO CLOSE TIMER IS SET, WHEN THE CLOSE OBSTRUCTION INPUT IS CLEARED, THE GATE WILL CLOSE WHEN THE AUTO CLOSE TIMER EXPIRES.
COM REV	REVERSE	CONNECT TO NORMALLY OPEN DEVICES TO CAUSE A REVERSAL WHEN THE GATE IS TRAVELING CLOSED. THE GATE WILL REVERSE TO THE FULL OPEN POSITION.
OPEN LOOP OPEN LOOP	OPEN LOOP	CONNECT TO OPEN LOOP/FREE EXIT LOOP. THE GATE WILL OPEN WHEN THE LOOP IS TRIGGERED, AND REMAIN OPEN AS LONG AS THE LOOP IS TRIGGERED. REQUIRES LOOP DETECTOR.
REVERSE LOOP REVERSE LOOP	REVERSE LOOP	CONNECT TO REVERSE LOOP. TRIGGERING THE LOOP WILL CAUSE A REVERSAL WHEN THE GATE IS TRAVELING CLOSED. THE GATE WILL REVERSE TO THE FULL OPEN POSITION. REQUIRES LOOP DETECTOR.
SHADOW/RESET LOOP SHADOW/RESET LOOP	SHADOW/RESET LOOP	CONNECT TO SHADOW/RESET LOOP TO KEEP THE GATE IN ITS FULLY OPEN POSITION AS LONG AS THE SIGNAL IS PRESENT. USED TO KEEP GATE OPEN WHILE VEHICLE IS PASSING THROUGH. REQUIRES LOOP DETECTOR.
- +	ALARM	FACTORY CONNECTED TO THE ALARM BEEPER.
N.O. COM N.C.	AUX RELAY	FOR CONNECTION TO AUXILIARY DEVICES (MAGNETIC LOCK, SOLENOID LOCK, STROBE LIGHT) FOR ACTIVATION (OR DEACTIVATION) DURING GATE OPERATION.
+ -	24 VOLT SOLAR PANEL	FOR CONNECTION TO 24 VOLT SOLAR PANEL FOR BATTERY CHARGING.
+ -	24 VOLT BATTERY	FACTORY CONNECTED TO BATTERIES IN DC MODEL OPERATORS.

Operator Accessory Connections

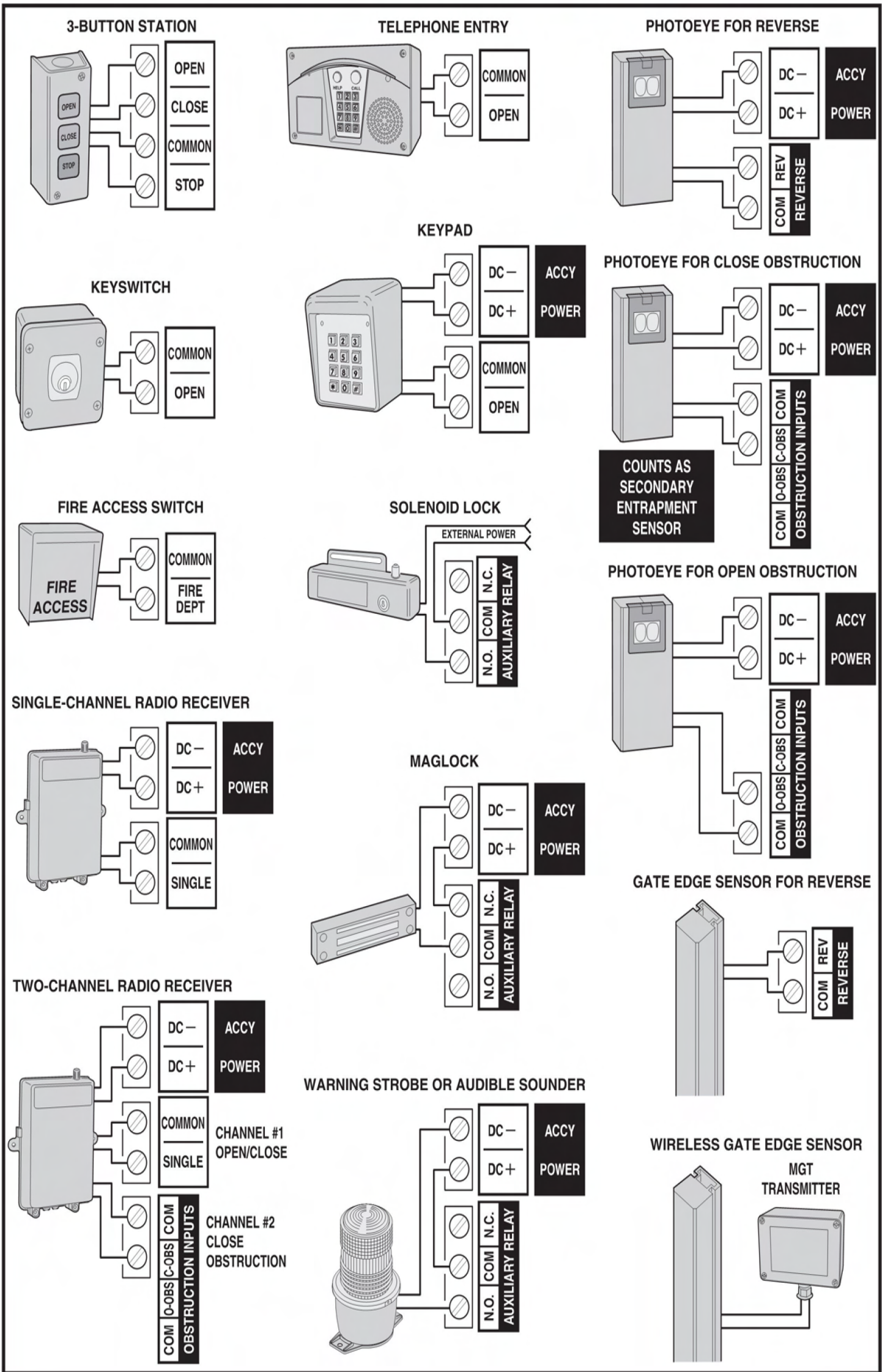

Basic Controller Programming

Programming Overview

The Controller can be programmed with various options for the operator. The programming fields are defined as "functions" that have "options". To make setup easier for the installer, the Controller's programming is divided into two groups: basic and advanced. The basic programming group contains the functions commonly used in most gate installations. The advanced programming group contains functions less commonly used (i.e. dual gate stagger delay, maximum run timer, etc.).

Entering Program Mode

Enter programming mode by pressing the **UP** and **DOWN** buttons together for one second. While in programming mode the **PROGRAM** indicator will light.

Exit Program Mode

Exit programming mode at any time by pressing the **UP** and **DOWN** buttons together. The Controller will automatically exit programming mode after three minutes of inactivity.

Programming Keystrokes

(Typical Programming Method)

While in programming mode, press the **UP** or **DOWN** buttons to scroll through the programming functions. When the desired function is displayed press the **ENTER** button to display the currently set option for the function. **When an option is displayed, the decimal points are lit.**

To change the option, press and hold the **ENTER** button for 1 second. To indicate that an option is ready to be changed, the display will flash. While the display is flashing, press the **UP** or **DOWN** button to display the other options available for that function.

When the desired option is displayed, press the **ENTER** button to store it into memory. To select another function, press **ENTER, UP, or DOWN**.

Left or Right Hand Operation

The factory default is for right hand operation (operator on right side of the driveway when viewed from the inside of the gate). For left hand installations, program the Controller for left hand operation.

Dual Gate Enable

The factory default is for single gate operation. For dual gate operation, wire the two gate controllers together through the **COMM LINK** terminals and enable dual gate operation with this programming step.

✓ **NOTE:** The Mid-Travel Stop feature is disabled when dual gate operations is enabled for paired units.

Auto Close Timer

The factory default turns off the Auto Close Timer. The timer can be set from 1 to 59 seconds and from 1 to 9 minutes. When the Auto Close Timer is set, after opening, the gate will wait for the length of the Auto Close Timer then close automatically.

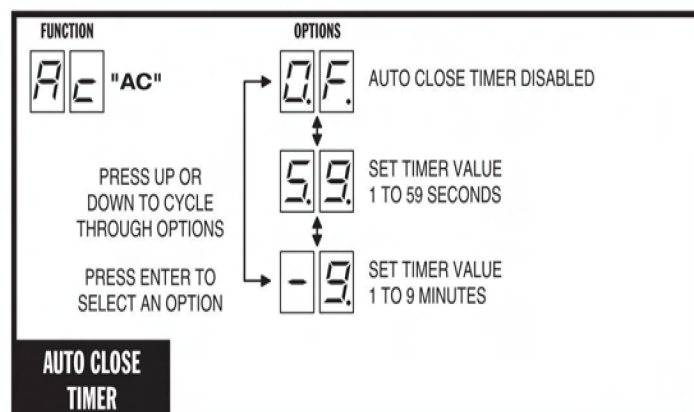
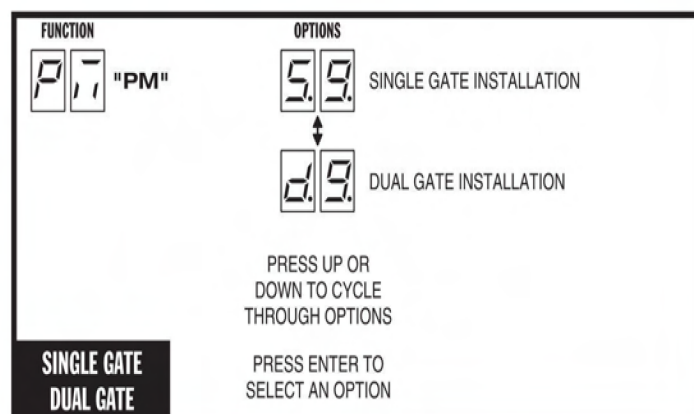
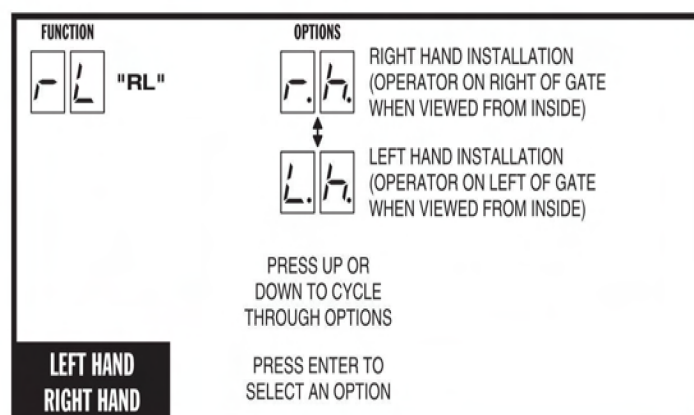
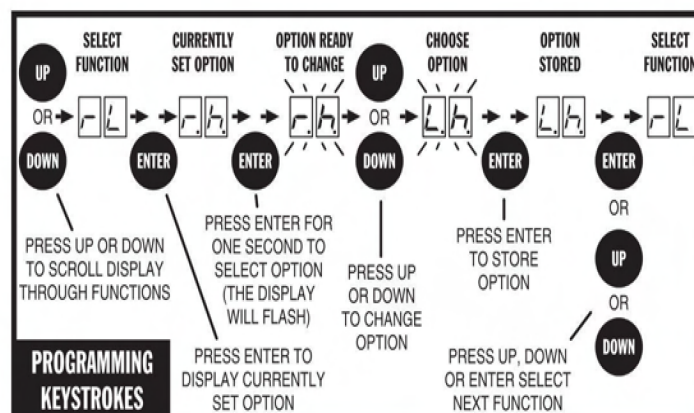
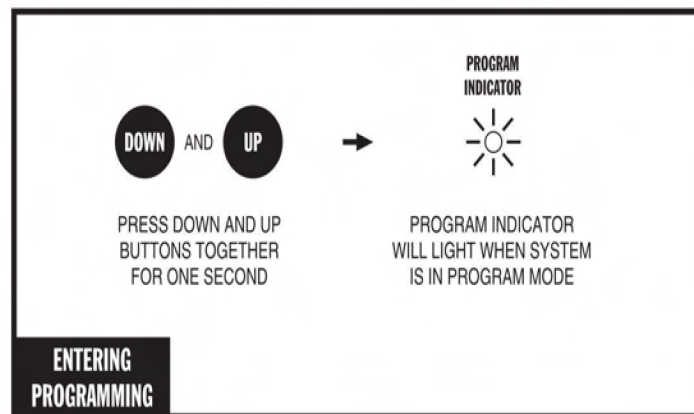

Basic Controller Programming (Cont.)

Run Alarm and Pre-start Alarm

The factory default is Run Alarm on and a 3-second Pre-start Alarm. The operator's beeper will sound 3 seconds before the operator starts. The options are:

- Run Alarm Off and Pre-start Alarm Off
- Run Alarm On and Pre-start Alarm Off
- Run Alarm On and Pre-start Alarm On for 1-9 Seconds

Maximum Open Direction Current Setting

To detect obstacles or mechanical problems with the gate, the operator monitors its motor current. If the open current load exceeds the programmed maximum load range number, the operator will stop, reverse a short distance, then stop again. The Auto Close Timer will be disabled, and another open request will be required to start the operator again. If after restart, the overload or an open obstacle happens again before the open limit is reached, the operator will lockout and sound the alarm.

To measure the motor load used during opening, **while this function is being displayed**, push and hold the **OPEN** button to fully open the gate. During movement, the motor current will be displayed as a load number from 0 to 99. This number is useful for troubleshooting but not for setting the motor current. At the end of travel, a different number will flash. This number indicates the range above and below the average motor current during the run. Using the + and - buttons, set the programmed range number so that a minimal force (50-75 lbs.) will activate a reversal should an obstruction occur, but high enough to keep the gate moving under normal conditions without interruption.

Maximum Close Direction Current Setting

To detect obstacles or mechanical problems with the gate, the operator monitors its motor current. If the close current load exceeds the programmed maximum load range number, the operator will stop, reverse, and travel to the full open position. Should a open obstruction input or an open direction inherent entrapment condition occur prior to the gate reaching the open limit, the operator will lockout and sound the continuous tone alarm. Another close request will be required to start the operator again. If after restart, the overload or a close obstacle happens again before the close limit is reached, the operator will lockout and sound the alarm. If the auto close timer is set, when the close obstruction input is cleared, the gate will close when the auto close timer expires.

To measure the motor load used during closing, **while this function is being displayed** push and hold the **CLOSE** button to close the gate. During movement, the motor current will be displayed as a load number from 0 to 99. This number is useful for troubleshooting but not used for setting the motor current. At the end of travel, a different number will flash. This number indicates the range above and below the average motor current during the run. Using the + and - buttons, set the programmed range number so that a minimal force (50-75 lbs.) will activate a reversal should an obstruction occur, but high enough to keep the gate moving under normal conditions without interruption.

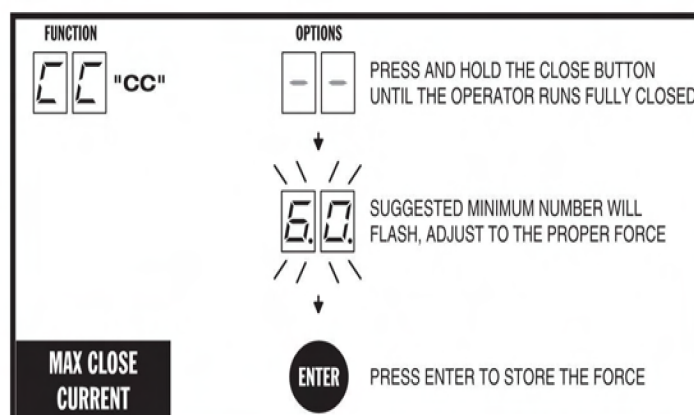
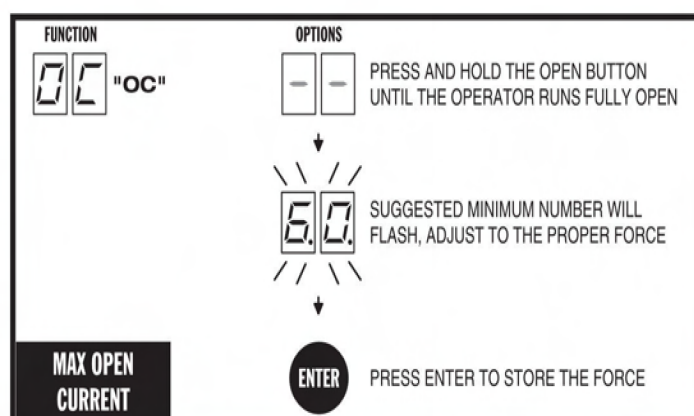
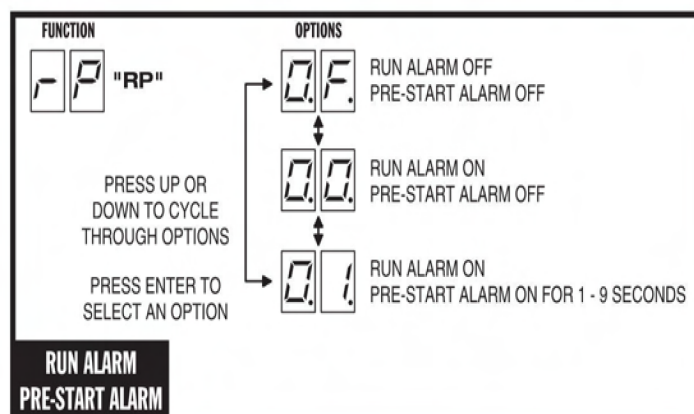

Advanced Controller Programming

Enter Advanced programming Mode

To access and program the Advanced Programming functions, for each programming session, Advanced Programming must be enabled.

After exiting programming, the Advanced Programming functions will be available on the programming display during the next programming session unless the operator has run 50 or more cycles. After that, Advanced Programming must be enabled again.

Maximum Run Time

The factory default for the Maximum Run Time (MRT) is 99 seconds. When the operator starts, a timer will begin counting. If a open or close limit is not reached or an obstacle or reversing input is not received before the timer expires, the operator will stop, the unit locks out and the alarm sounds. The timer can be set for 10 to 99 seconds, but should be left at 99 in most applications. Setting it too close to the actual run time may cause the time to expire with changing ambient temperature, gate conditions, etc...

If AC is present and an open or close limit is not reached or an obstacle or reversing input is not received before this timer exceeds MRT, the operator will stop, the unit locks out and the alarm sounds.

In the case that AC is not present and MRT expires, it will be ignored as long as the actual run time is under 99 seconds. When the gate reached full open or full close position, MRT will be interpreted as fail safe/secure. EN05 will occur. If FS as set to fail safe, the gate will open. If FS is set to fail secure, the gate will close. However, if the actual run time is higher than 99, it will be interpreted as a physical mechanical problem, EN01 will occur and the gate will stop immediately.

Single Button Input Setup

This function is used for selecting the operation for single button controls and radio receivers.

The factory default sets the **SINGLE** input terminal so successive inputs will cycle the operator in OPEN-STOP-CLOSE-STOP order.

Alternately, the **SINGLE** input can be set to cause the gate to OPEN unless the gate is fully open. If the gate is fully open, the input will cause the gate to CLOSE.

Stagger Mode

This function is used in dual gate installations only. The factory default sets the Stagger Mode to OFF. In dual gate installations the two operators communicate through the 3-wire **COMM LINK** interface. When using the Stagger Mode, set one operator for delayed opening and the other operator for delayed closing. The Stagger Time programming function (see below) sets the length of the delay.

✓ **NOTE:** This function will only be displayed if dual gate operation is selected.

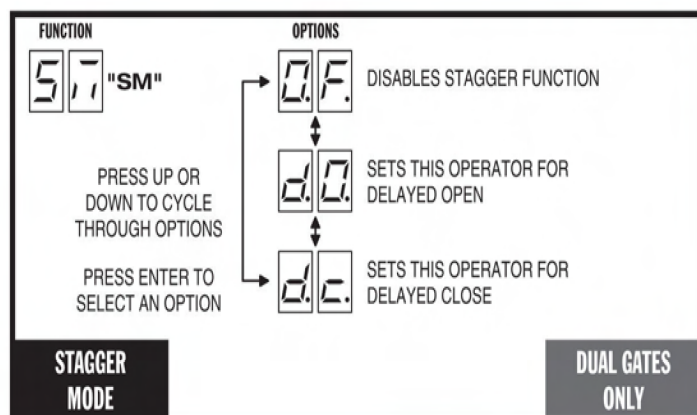
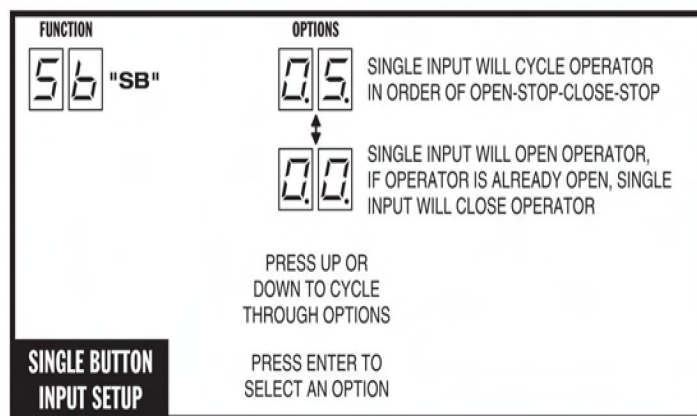
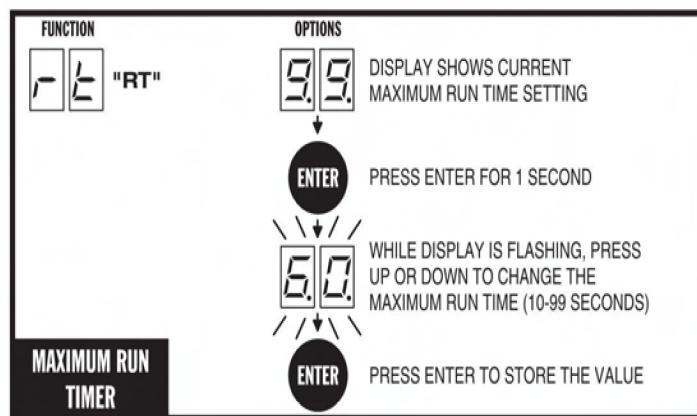
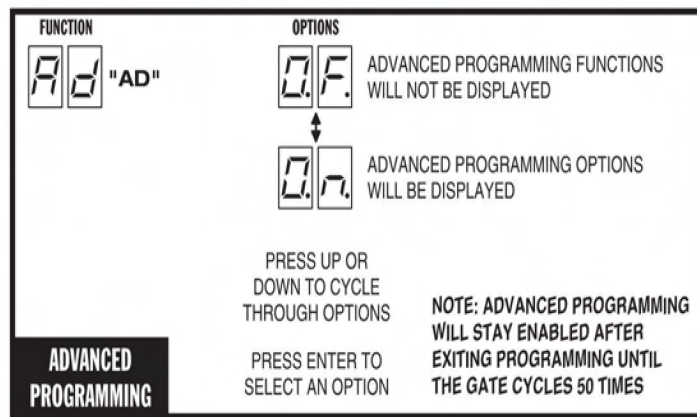

Advanced Controller Programming (Cont.)

Stagger Delay Time

This function is used in dual gate installations only. The factory default sets the Stagger Time to 0 seconds (OFF). The Stagger Time sets the delay for the Stagger Mode. The Stagger Delay Time can be set from 1-99 seconds.

✓ **NOTE:** This function will only be displayed if dual gate operation is selected.

Auxiliary Relay Mode

The Auxiliary Relay has normally open and normally closed contacts. The factory setting disables the Auxiliary Relay. The relay can be set for:

- **Maglock:** To deactivate a magnetic or solenoid gate lock, the relay will energize during any pending or actual gate motion (open only).
- **M4:** To deactivate a magnetic or solenoid gate lock, the relay will energize during any pending or actual gate motion (open only). 3 seconds after the gate starts to move, the relay will de-energize. This option is used for higher current solenoid locks.
- **Ticket Dispenser:** The relay will energize while the gate is moving in the open direction and at the full open limit, or in an entrapment condition.
- **Strobe:** To activate a warning strobe light, the relay will energize during any pending or actual gate motion (either open or close).
- **Alarm:** The relay will energize if the gate is manually forced open from the full closed position.

Reverse Delay Time

The factory default sets the Reverse Delay to 1 second. The operator will wait the length of the delay before reversing direction. This feature will not change the reversal time when the operator is responding to an entrapment condition from an obstruction input or inherent entrapment protection sensor. The Reverse Delay can be set from 1 to 9 seconds. Heavier gates require a longer delay to allow time for the gate to stop.

Constant Pressure Mode

The factory default allows momentary pressure on a control station's **OPEN** or **CLOSE** button to cycle the operator. The controller can be set to require constant pressure on the **OPEN**, **CLOSE**, or both buttons to run the operator.

✓ **NOTE:** If a button is set for constant pressure, and it is released before the operator reaches the open or close limit, the operator will stop the gate at its current position.

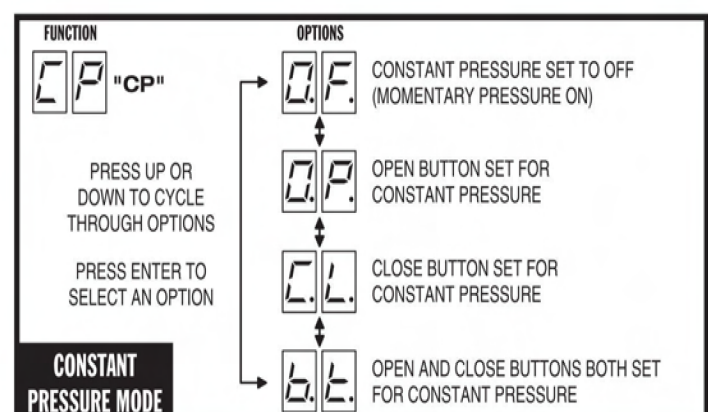
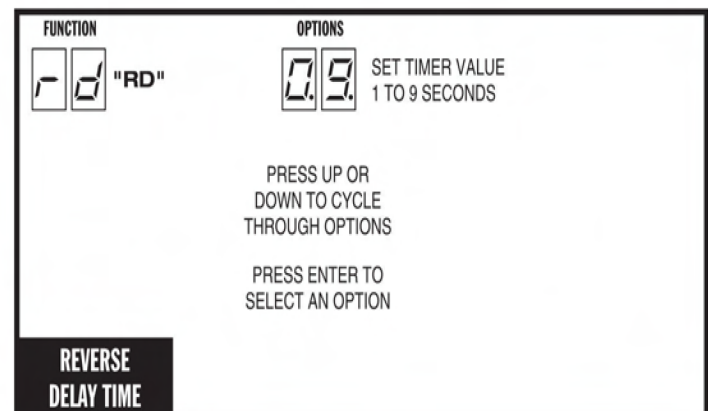
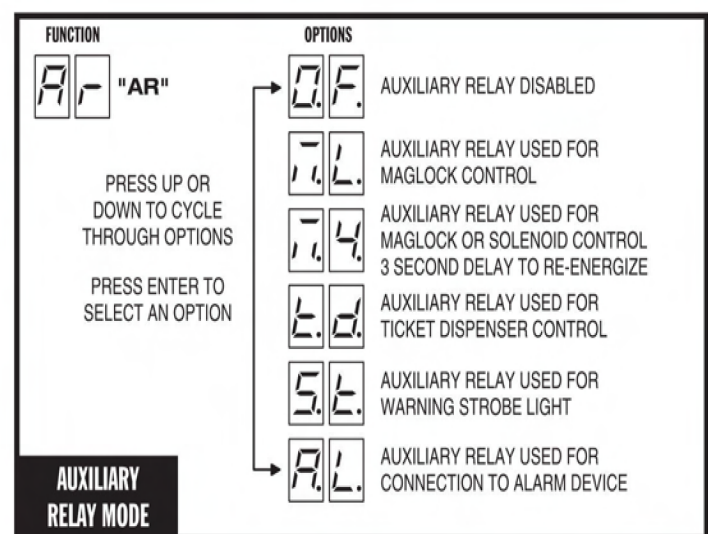
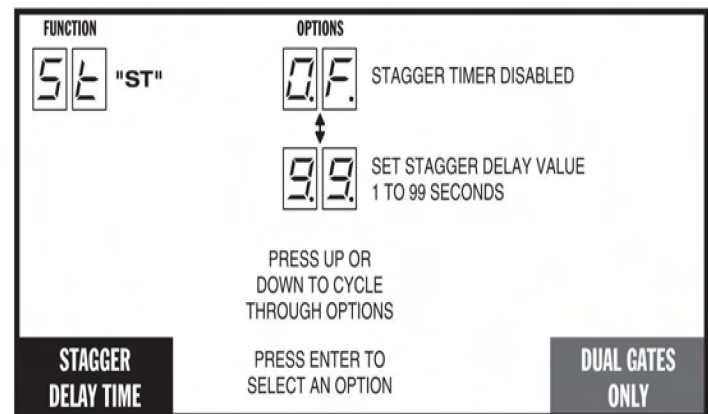

Advanced Controller Programming (Cont.)

Shadow Loop Open Prevention

If the shadow loop is triggered, it always prevents the gate from closing if the Auto Close Timer activates or a CLOSE command is given while the gate is at the full open position.

The controller can also be set to prevent the gate from opening if the shadow loop is triggered while the gate is at the close limit position. This prevents a swing gate from opening into a vehicle if it's parked near the gate on the inside.

Low Power Mode

NOTE: This function is only used with DC Models. The factory default disables the Low Power Mode. When Low Power Mode is enabled, and AC power fails, the controller will assume Low Power Mode after 60 seconds of gate inactivity. Low power mode turns off all accessory power and indicators. Only inputs from the radio receiver, reverse loop, open loop (optional by programming), fire department input, or restoring AC power will wake the Controller from Low Power Mode. Programming Mode can still be accessed while the Controller is awake in Low Power Mode.

Power Failure Mode

NOTE: This function is only used with DC Models. The factory default is set for Fail Safe, alternately the Controller can be set for Fail Secure, Open Immediate, or Close Immediate.

- **Fail Safe:** If the AC power fails and the battery voltage drops below approximately 22 Volts, 5 seconds later the operator will cycle open if not already open. When AC power is restored, or the battery gets charged by solar panels, the operator will resume normal operation and auto-close if programmed to do so.
- **Fail Secure:** If the AC power fails and the battery voltage drops below approximately 22 Volts, 5 seconds later the operator will cycle closed if not already closed. When AC power is restored, or the battery gets charged by solar panels, the operator will resume normal operation.
- ✓ **NOTE:** Fail Safe and Fail Secure are disabled if Stagger Mode is enabled.
- **Open Immediate:** If the AC power fails, the operator will cycle open if not already open and cease operation. When AC power is restored, the operator will resume normal operation and auto-close if programmed to do so.
- **Close Immediate:** If the AC power fails, the operator will cycle closed if not already closed and cease operation. When AC power is restored, the operator will resume normal operation.

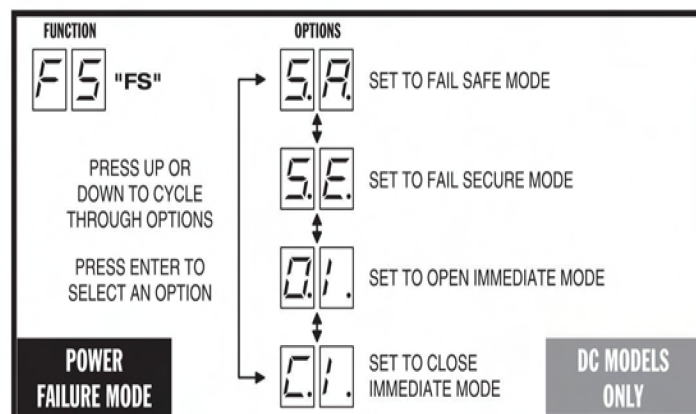
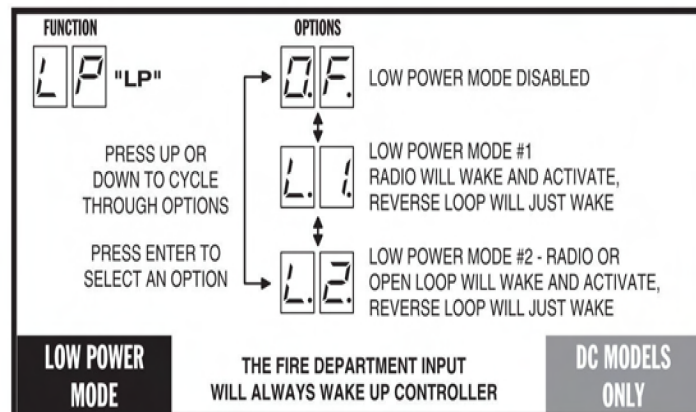
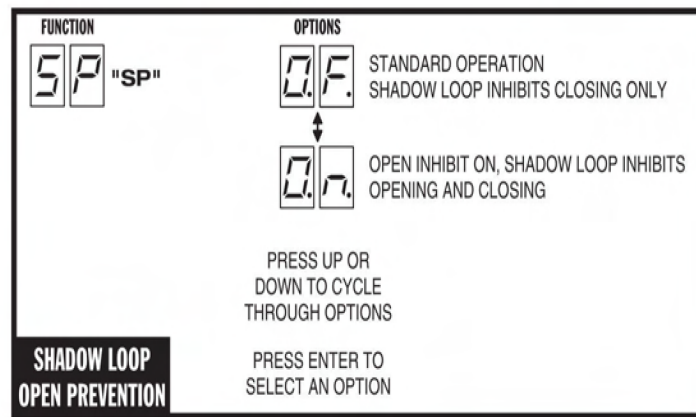

Advanced Controller Programming (Cont.)

Soft Start/Stop Duration.

NOTE: This function is only used with DC Models. This function causes the operator to start and stop the DC motor slowly reducing gate wear and tear (at the full open or closed positions only). The factory default sets the Soft Start/Stop Duration to 3 seconds. The Soft Start/Stop Duration can be set from 1 to 10 seconds.

✓ **NOTE:** Changing the Soft Start/Stop Duration will reset the OPEN and CLOSE CURRENT setting value to zero. It will be necessary to reprogram maximum open and close current settings.

Reset Cycle Counter

The Controller counts of the number of times the operator has been cycled full open and close. The cycle count can be displayed. The display will scroll the cycle count number, flashing two digits at a time from left to right.

To reset the Cycle Count, press and hold the **ENTER** button for 2 seconds while the Cycle Count is displayed.

If the Maintenance Alert has been triggered, resetting the Cycle Count will also reset the Maintenance Alert indicator.

The Controller has a **MAINT ALERT** indicator that can be programmed to light when the number of activations exceeds a set number of cycles.

The factory default sets the Maintenance Alert Trigger to 10,000 cycles. The Maintenance Alert Trigger can be programmed for 5, 10, 15, or 25 thousand cycles.

The Maintenance Cycle Count can be reset independently from the operator's absolute Cycle Count.

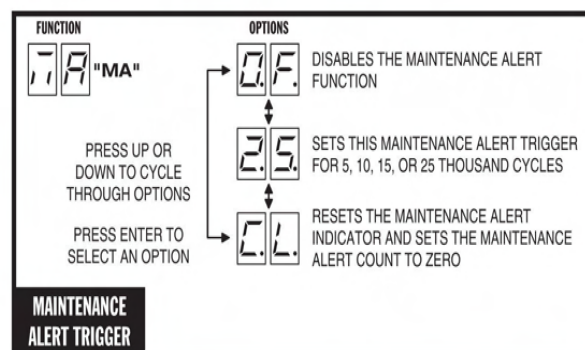
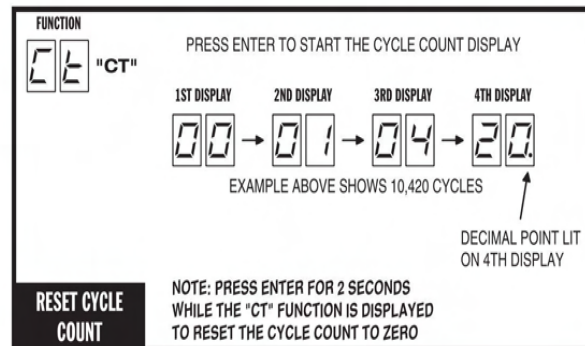
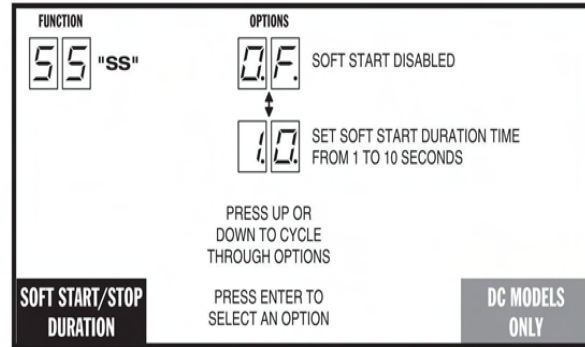

Mid-travel Stop Position

The Controller can be programmed so the gate will stop at a mid-travel point instead of fully opening. This can be useful in installations where a large gate, that takes a long time to open and close fully, only needs to be opened partway to allow traffic to pass.

The factory default sets the Controller for full open operation. Alternately, the Controller can be programmed to open for 1 to 99 seconds then stop, before reaching the open limit.

When a Mid-travel Stop Position time has been programmed, the gate will **still fully open** if the Fire Department input is triggered, if the **OPEN** button is held down beyond the Mid-travel Stop Position, or a close obstruction or reverse loop input is triggered.

- ✓ **NOTE:** The Mid-travel Stop feature is disabled when dual gate operation is enabled for paired units.
- ✓ **NOTE:** The Mid-travel Stop feature should not be used to allow pedestrian traffic.

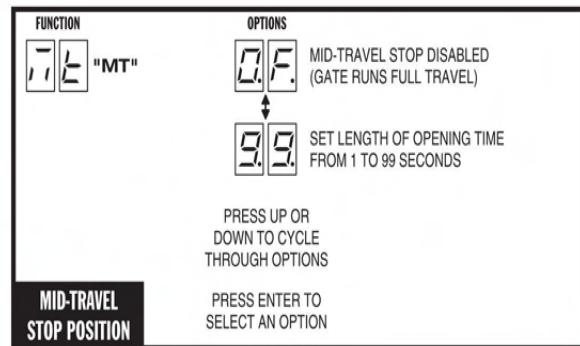

Anti-tailgate Enable

The factory default sets the Anti-tailgate Enable to OFF. With this setting, during a gate cycle, after the shadow loop has been triggered by the vehicle and then has cleared after the vehicle passes, the Auto Close Timer or a CLOSE command is required to begin closing the gate.

If the Anti-tailgate Enable is set to ON, the gate will close immediately as soon as the shadow loop has cleared. Any subsequent shadow loop triggers while the gate is closing will stop the gate. When the shadow loop clears, the gate will continue closing.

Motor Type Selection

The factory sets the default for the Controller to match the type of motor in the operator. If required, change the motor selection option to a different type of motor used in the operator. The options available are:

- AC Motor Only
- DC Motor Only with Mechanical Braking
- DC Motor with Electronic Soft Start/Stop
- 3 Phase AC Motor
- AC Motor with DC Motor Backup with Mechanical Braking
- AC Motor with DC Motor Backup with Electronic Soft Start/Stop

- ✓ **NOTE:** This setting is preset at the factory and should not be changed.

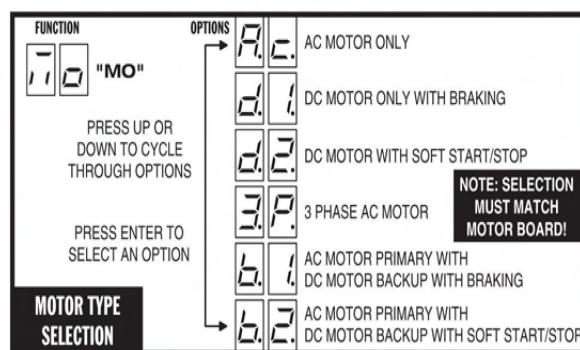
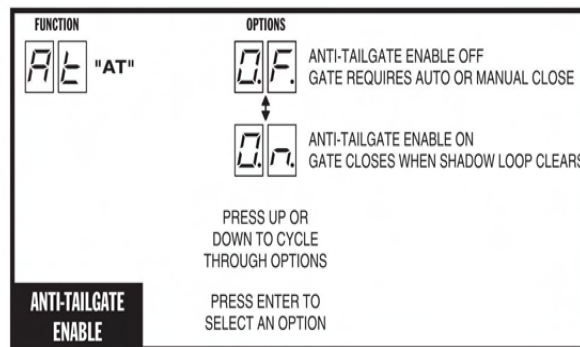

Advanced Controller Programming (Cont.)



Radio Enable

The Controller contains a built-in MegaCode® radio receiver to allow activation from up to 40 access control transmitters and two Model MGT (gate edge) transmitters. The factory default enables the internal radio receiver. Alternately, the internal receiver can be disabled.

Antenna Installation

The Controller is supplied with a local whip antenna installed. If using a remote antenna, remove the whip antenna and connect coax cable from the antenna to the **ANTENNA** connector.

Radio Transmitter Learn

The Controller's built-in MegaCode® radio receiver can store the IDs of up to 40 transmitters. Refer to the figure for the steps required to learn transmitters.

✓ **NOTE:** This function will not be displayed if the transmitter memory is full, or if the receiver is disabled.

Radio Transmitter Delete

Transmitters can be deleted from the Controller's memory either individually, or all at the same time. Refer to the figure for the steps required to delete transmitters.

✓ **NOTE:** This function will not be displayed if no transmitters are stored in memory, or if the receiver is disabled.

MGT Obstacle Transmitter Learn

The Controller supports one or two Model MGT Obstacle Transmitters. The transmitters can be programmed to function as Open Obstruction, Close Obstruction, Reverse, or Stop. Refer to the figure for the steps required to learn MGT transmitters.

✓ **NOTE:** This function will not be displayed if two MGT Obstacle Transmitters are already stored in memory, or if the receiver is disabled.

MGT Obstacle Transmitter Delete

MGT transmitters can be deleted from the Controller's memory either individually, or all at the same time. Refer to the figure for the steps required to delete MGT transmitters.

✓ **NOTE:** This function will not be displayed if no MGT Obstacle Transmitters are already stored in memory, or if the receiver is disabled.

Reset Controller to Factory Defaults

The Controller can be reset with this function. **ALL PROGRAMMED DATA WILL BE LOST**, and the factory defaults will be loaded. This function will not erase radio transmitters, current sense values, or motor type. Transmitters must be deleted with the two functions above.

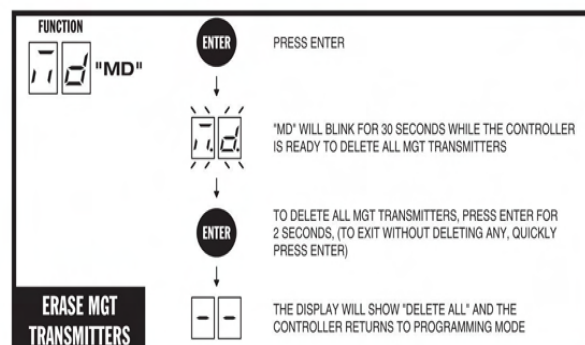
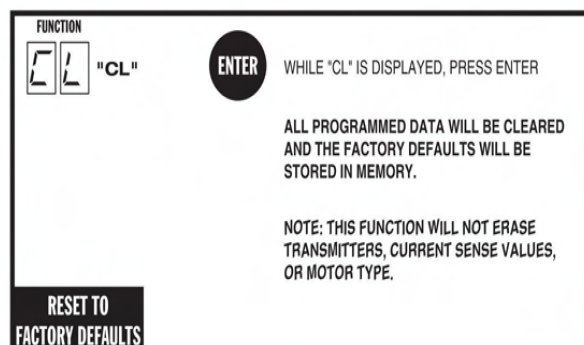
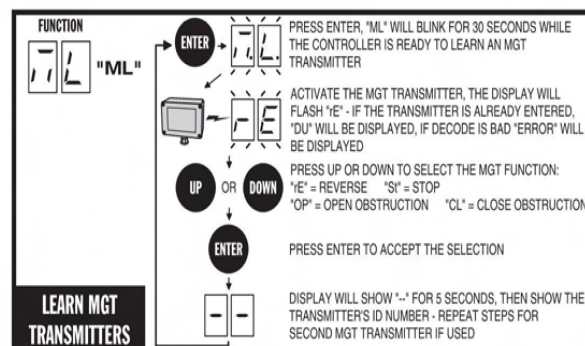
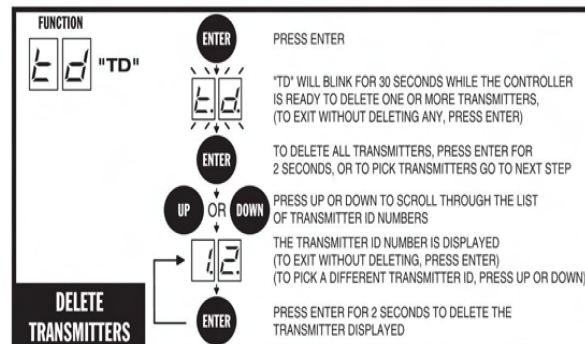
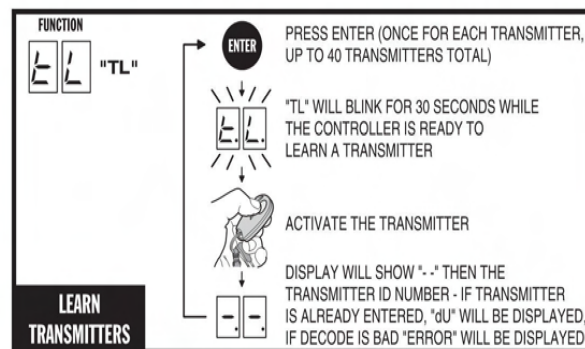
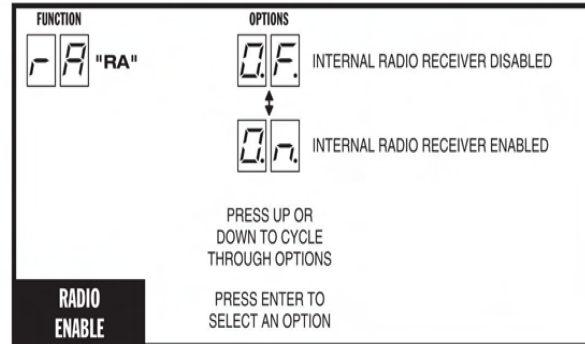

Dual Gate Installations

Two operators can be used in dual gate installations. The operators communicate with each other through the 3-wire **COMM LINK** terminals.

When one operator activates, the **COMM LINK** connection signals the other operator to activate. Each operator functions independently, controlling its gate and monitoring its inputs and accessories.

A three-wire shielded conductor cable is required to connect two operators together for dual operation. Use Belden 8760 Twisted Pair Shielded Cable (or equivalent) only.

✓ **NOTE:** The Shield wire should be connected to COMM LINK terminal "C" in both operators.

Three of the programming functions available are only used for dual gate installations:

- **Dual Gate Enable**
Dual Gate Enable must be set for all dual gate installations.
- **Stagger Mode**
The Stagger Mode function determines if the operator has a delayed open or a delayed close. In dual swing gate installations, typically one operator is programmed for delayed open, and the other operator is programmed for delayed close.
- **Stagger Delay Time**
The Stagger Time sets the length of the delay for the Stagger Mode.

See Pages 4, 6, & 7 for details on these three dual gate programming functions.

Set the following parameters in each gate operator individually in a single gate mode before connecting the network cable and operating in dual gate mode.

1. Open and Close Limit settings
2. Open and Closed direction inherent entrapment protection (OC & CC)

After these parameters have been set, and each operator has been tested independently and is functioning correctly in single gate mode, then set BOTH operators to dual gate (dg) in the Paired Mode setup step under Basic Programming steps.

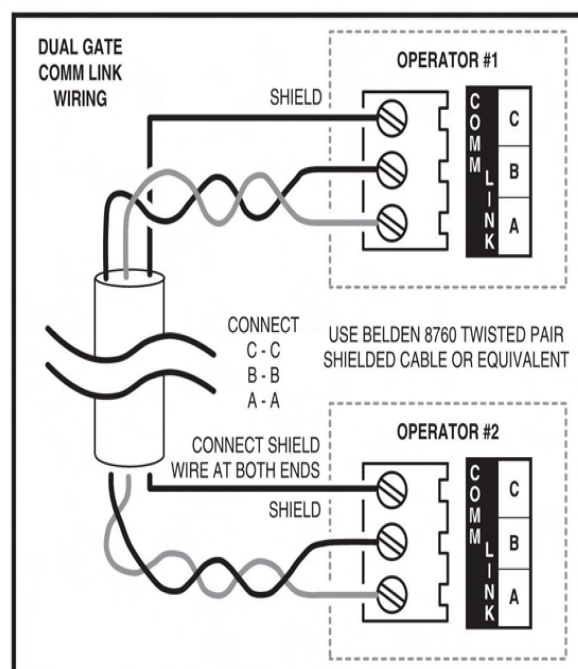

✓ **NOTE:** The Shield wire should be connected to COMM LINK terminal "C" in both operators.

Gate Operation



Open Button

Opens the gate. If the Controller is programmed to stop opening the gate at mid-travel, a constant press of the **OPEN** button will override the Mid-travel Stop and completely open the gate. If the Auto Close Timer is set, it will be suspended until the **OPEN** button is released.

Close Button

Closes the gate if the gate is open. Also closes the gate if the gate is in the process of opening.

Stop Button

Stops the gate from opening or closing at any time.

Single Input

Opens the gate if it's closed and closes the gate if it's open (open-close programming option). Activating the input while the gate is moving will reverse the gate.

Can be programmed to stop the gate while the gate is moving (open-stop-close programming option).

Fire Department Input

Fully opens the gate when the input is activated. Overrides the Mid-travel Stop and Auto Close Timer (if either is programmed for the gate). The gate will lockout in the open position without sounding the alarm. Press the **STOP** button to release the lockout.

Open Input

Functions the same as the **OPEN** button.

Open Obstruction

While the gate is opening, any open obstruction signal will cause the gate to stop, reverse a short distance, and then stop again. The Auto Close Timer will be disabled, and a renewed input will be required to start the gate again. Should the gate be restarted and the obstacle signal occur again prior to reaching a limit, the gate will stop again, lockout, and sound the emergency alarm.

Close Obstruction

While the gate is closing, any close obstruction signal will cause the gate to stop, reverse, and travel to the full open position. Should a open obstruction input or an open direction inherent entrapment condition occur prior to the gate reaching the open limit, the operator will lockout and sound the continuous tone alarm. Another close request will be required to start the operator again. If after restart, the overload or a close obstacle happens again before the close limit is reached, the operator will lockout and sound the alarm. If the auto close timer is set, when the close obstruction input is cleared, the gate will close when the auto close timer expires.

Reverse Input

If the reverse input is triggered while the gate is closing, the gate will reverse to the full open position. If the Auto Close Timer is set, when the reverse input is cleared, the gate will close when the Auto Close Timer expires.

Open Loop

Functions the same as the **OPEN** button.

Reverse Loop

Functions the same as the reverse input.

Shadow / Reset Loop

Holds the gate fully open or fully closed while triggered. If open, the gate closes immediately when cleared if Anti-tailgate is enabled.

Operation Indications

During normal operation, the Controller's displays will indicate current operating conditions and status.

Power-up Display

When the Controller powers up, dashes will show on the display, then the firmware version number, then the gate type (SL= Swing or Slide, BG Single ArmBarrier, BS Wishbone Barrier).

Exiting programming restarts the Controller. The power-up display will show upon the restart.

Idle Condition

While the Controller is idling, waiting for a command, the display will show circulating dashes.

For DC models only - Clockwise : Batteries discharging,
Counterclockwise : Batteries charging.

Last Gate Position/Condition

When the gate moves or stops, the display will show the status for up to one minute.

- Stop is displayed as $S\bar{L}$
- Full Close is displayed as $F\bar{C}$
- Full Open is displayed as $F\bar{O}$
- Entrapment is displayed as $E\bar{n}$

Pre-start Delay

During the pre-start delay, the display will countdown the number of seconds remaining before the operator starts.

Reverse Delay

If the gate travel direction is reversed from a user activation or reversing device, and a reverse delay is set, the display will count down the delay time in seconds before the operator restarts.

Run Timer

While the gate is opening or closing, the number of seconds running time is displayed.

Error Indications

During abnormal operation, the Controller's displays and beeper will indicate the error condition that has occurred.

Entrapment

If an entrapment condition occurs detected by two repeated open or close obstruction triggers, the Controller will lock the operator out. The beeper will sound constantly and the gate will not operate. To reset the Controller press the **STOP** button



COMM LINK Connection Failure

In dual gate installations, if there is a connection failure between the two operators, the **COMM LINK** indicator will blink once a second. During this condition the gate will not operate, except if triggered by the **FIRE DEPT** input, which functions normally.

MGT Obstacle Transmitter Trouble

If any MGT transmitters are used with the operator, their supervision feature will alert the Controller if there is any trouble with the transmitter. MGT transmitters send hourly status reports and will send low battery reports when the transmitter has a low battery. The MGT transmitters also have a tamper detection switch that will trigger when their case is opened.

When the Controller detects a low transmitter battery, a tamper signal, or missing transmitter status reports, the gate will still operate normally, but the beeper will change as follows:

- The Pre-start Alarm will beep twice as fast.
- The Run Alarm will beep twice as fast and continue for five minutes after the gate stops.
- The sounder will "chirp" every five seconds when the gate is idle.

Correct the trouble (close case, replace battery, or replace transmitter) to clear the obstacle transmitter trouble indications.

Maximum Run Timer Exceeded

If the Maximum Run Time is exceeded, the Controller stops the operator the same as if a double obstacle has occurred in an entrapment condition. The entrapment alarm sounds constantly, and is cleared by pressing the **STOP** button or the **RESET** button on the cover. After the **STOP** or **RESET** button is pressed, because the Maximum Run Time has been exceeded, the sounder will beep twice every five seconds. The next operation of the gate will clear the indication.

CONTROLLER ERROR CAUSES AND INDICATIONS		
ERROR CAUSE	ERROR INDICATION	HOW TO CLEAR
TWO SAFETY REVERSALS (ON SINGLE GATE OR ON EITHER DUAL GATE)	<i>E_n 00</i> , CONTINUOUS ALARM BEEPER, GATE DISABLED	PRESS STOP BUTTON
MAXIMUM RUN TIMER EXCEEDED ON OPENING	<i>E_n 01</i> , AND MAX RUN LED, CONTINUOUS ALARM BEEPER, GATE DISABLED	PRESS STOP BUTTON, CLEARS CONTINUOUS ALARM, THEN DOUBLE BEEP EVERY 5 SECONDS UNTIL NEXT OPERATION
MAXIMUM RUN TIMER EXCEEDED ON CLOSING	<i>E_n 02</i> , AND MAX RUN LED, CONTINUOUS ALARM BEEPER, GATE DISABLED	PRESS STOP BUTTON, CLEARS CONTINUOUS ALARM, THEN DOUBLE BEEP EVERY 5 SECONDS UNTIL NEXT OPERATION
COMM LINK FAILURE	<i>E_n 03</i> , AND COMM LINK LED, CONTINUOUS ALARM BEEPER FOR 1 MINUTE, GATE DISABLED (EXCEPT FOR FIRE DEPT INPUT)	PRESS STOP BUTTON, CLEARS CONTINUOUS ALARM
GATE FULL OPEN RESULTING FROM FIRE DEPT INPUT	<i>E_n 04</i> , GATE DISABLED	PRESS STOP BUTTON
FAIL SAFE OR FAIL SECURE BECAUSE OF BATTERY VOLTAGE DROP BELOW 21.6 VDC DUE TO AC POWER LOSS	<i>E_n 05</i> , GATE DISABLED	BATTERY VOLTAGE MUST RISE ABOVE 24 VDC
OTHER CONTROLLER IN ENTRAPMENT (DUAL GATE)	<i>E_n 06</i> , GATE DISABLED	CLEAR ENTRAPMENT ON OTHER CONTROLLER (PRESS STOP)
LOW AC VOLTAGE AT CONTROLLER	<i>E_n 07</i> , GATE DISABLED	RESTORE AC POWER TO NORMAL LEVEL
INPUT TRIGGERED DURING ENTRAPMENT LOCKOUT	<i>E_n 08</i> , GATE DISABLED	PRESS STOP BUTTON
COMPATIBILITY PROBLEM	<i>E_n 09</i> , GATE DISABLED	UPDATE FIRMWARE AND RESET BOTH PAIRED CONTROLLERS
EEPROM PROBLEM	<i>E_n 10</i> , GATE DISABLED	TRY RESET, CALL TECH. SUPPORT
DC MOTOR MISMATCH	<i>E_n 11</i> , GATE DISABLED	REPROGRAM MOTOR TYPE OR CHANGE DC MOTOR BOARD, NEXT GATE MOVEMENT WILL RETRY DC MOTOR CHECK
MOTOR FAILURE	<i>E_n 12</i> , GATE DISABLED	CALL TECH. SUPPORT
AC POWER LOSS IN OPEN OR CLOSE IMMEDIATE POWER FAIL MODE	<i>E_n 13</i>	REAPPLY AC POWER
MAXIMUM RUN TIMER EXCEEDED AFTER AC POWER LOSS	<i>E_n 14</i>	BATTERY VOLTAGE MUST RISE ABOVE 24 VOLTS
MGT SUPERVISORY CONDITION (TAMPER, LOW BATTERY, MISSING HOURLY STATUS)	FAST BEEPS DURING PRESTART, FAST BEEP RUN ALARM, CHIRP EVERY 5 SECONDS AT IDLE	CLEARS WHEN MGT CONDITION CLEARS

PowerMaster

Limited 5-Year Warranty

PowerMaster warrants all gate operators to be free of defects in materials and workmanship for a period of five (5) years from date of manufacture. If any part is found to be defective during this period, new parts will be furnished free of charge. Failure of this product due to misuse, improper installation, alterations, vandalism, or lack of maintenance is not covered under this warranty, and voids any other implied warranties herein.

PowerMaster is not responsible for any labor charges incurred in connection with the installation of warranted parts.

In order to activate this warranty, the registration form below **MUST BE COMPLETED AND RETURNED WITHIN THIRTY CALENDAR DAYS FROM DATE OF PURCHASE**. Log onto our website at www.vepower.net and click on the *Register your Product* link. You can also send via fax (631-231-4274) or via email to pmtech@optonline.net. If registration is not activated, a one-year warranty will apply.

REGISTRATION INFORMATION

Operator Information

Model DSBG

Serial # _____

Date Installed _____

Location Installed

Address _____

Address _____

Address _____

Installer's Information

Company Name _____

Address _____

Address 2 _____

City, State, Zip _____

Telephone # _____

Contact Name _____

The end user should retain this information for their records and to obtain warranty service.

Need Technical Support?



Visit: www.vepower.net/faqs

Call us toll free @ 1-800-243-4476

Email us: PMtech@VEpower.net

powermaster



www.facebook.com/PowerMasterOperators

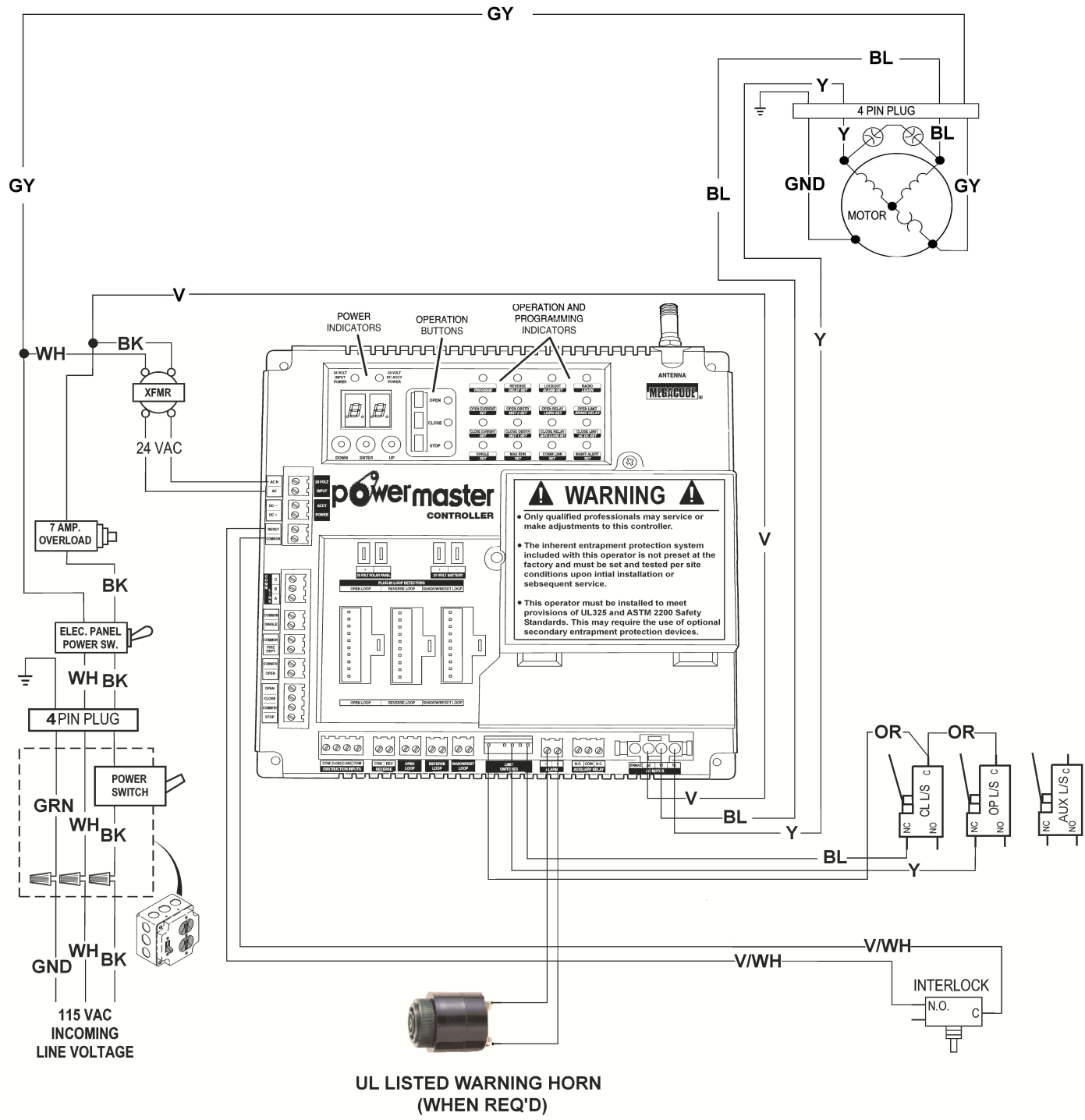

UL LISTED WARNING HORN
(WHEN REQ'D)

powermaster	
DATE: 10-29-14	P1500 / P5000
BY: RPL JR.	RPL SR
FOR USE WITH POWERMASTER SBG / WBG BARRIER GATE OPERATOR WITH POWERMASTER CONTROLLER.	
WD# 7000	REV.1
© Copyright PowerMaster 2014 No portion of this diagram may be reproduced without the expressed written permission of the manufacturer.	

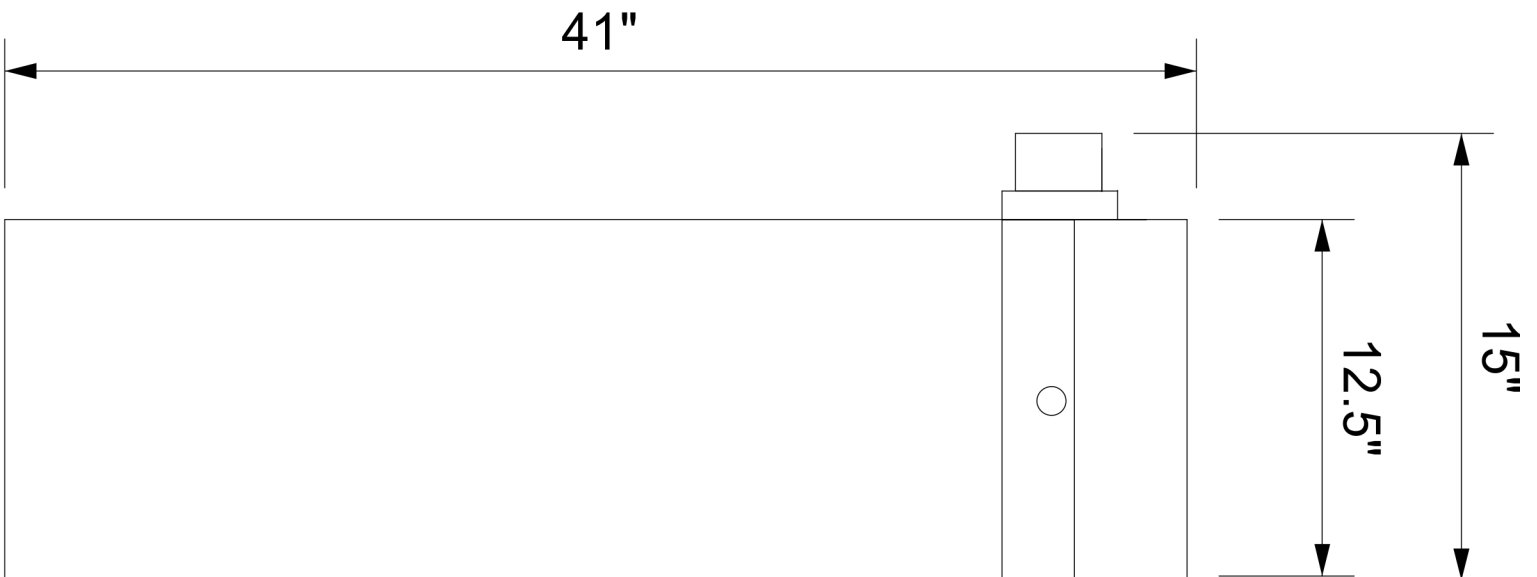
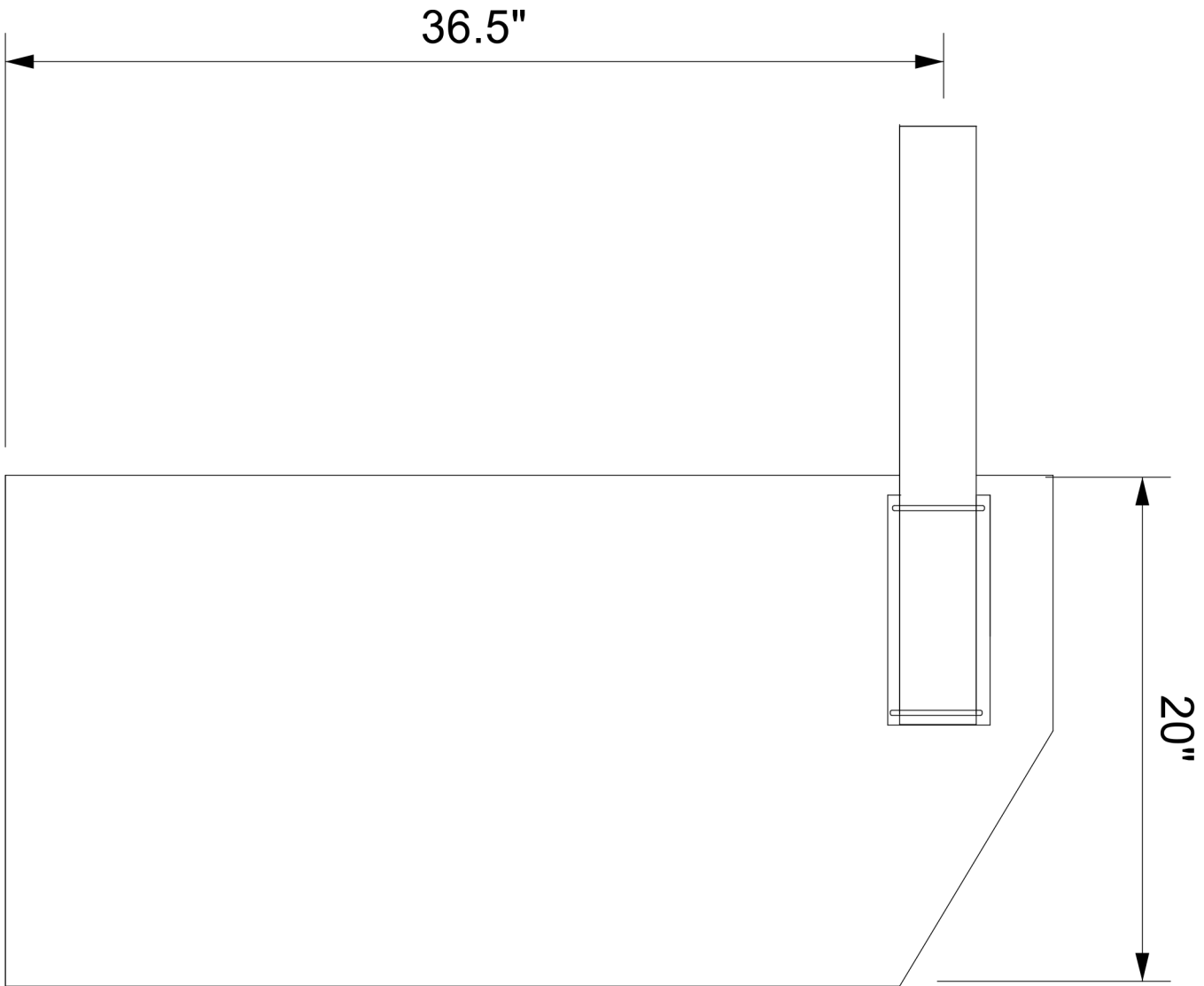

BARRIER GATE FLASHING LIGHT INSTALLATION

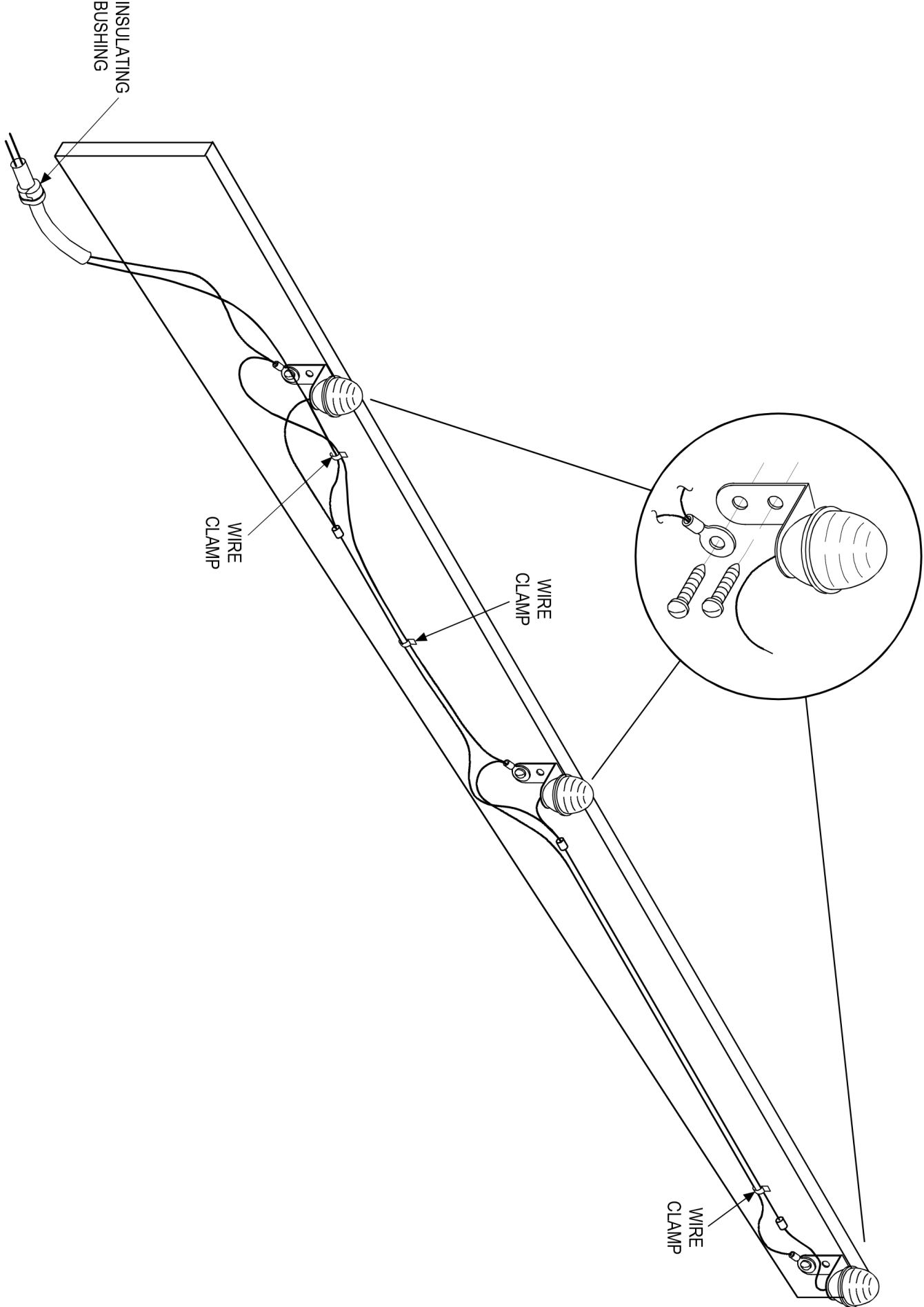

Need Technical Support?



Visit: www.vepower.net/faqs

Call us toll free @ 1-800-243-4476

Email us: PMtech@VEpower.net

powermaster



www.facebook.com/PowerMasterOperators